

March 1, 1938.

W. P. AULL

2,109,609

CIGARETTE RING

Filed Feb. 20, 1936

Fig. 1.

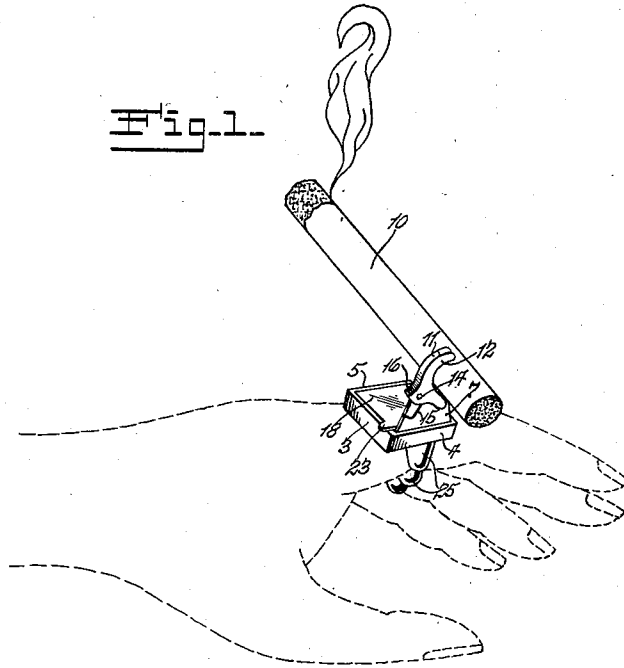

Fig. 2.

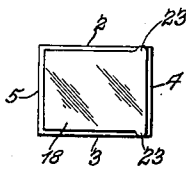

Fig. 3.

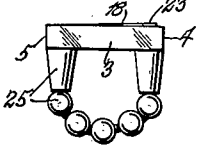

Fig. 4.

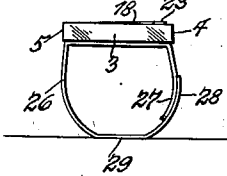

Fig. 5.

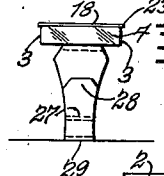

Fig. 6.

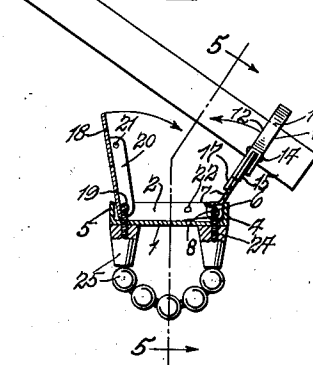

Fig. 7.

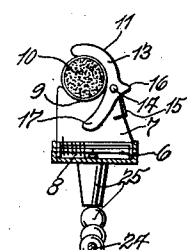

Fig. 8.

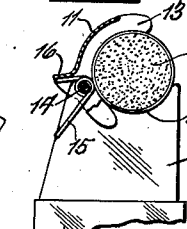
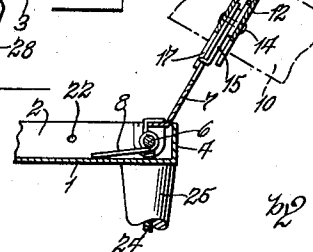

Fig. 9.



Inventor  
Watson L. Aull  
By Rippey & Cassidy  
His Attorneys

# UNITED STATES PATENT OFFICE

2,109,609

## CIGARETTE RING

Watson P. Aull, St. Louis, Mo.

Application February 20, 1936, Serial No. 64,839

11 Claims. (Cl. 131—51)

This invention relates to cigarette rings for holding cigarettes in connection with a finger of the left hand in a position to be conveniently brought into contact with the lips of the smoker.

5 Objects of the invention are to provide a cigarette ring adapted to be worn upon the forefinger of the left hand and equipped with means to receive and hold a cigarette firmly at an upward angle across the back of the hand and separated  
10 from the hand a sufficient distance so that the burning cigarette will not cause discomfort; to provide means conveniently manipulative to release and eject the butt of the cigarette; to provide means for enclosing and covering the cigarette holding devices when they are not in use;  
15 and to provide the holding devices so that they will move to and retain a position in which the burning end of the cigarette is inclined outwardly away from the back of the hand.

20 Other objects will be readily apparent from the following description, reference being made to the annexed drawing, in which—

Fig. 1 is a perspective view of my improved cigarette ring mounted on the forefinger of the left hand and showing the cigarette held thereby.

Fig. 2 is a plan view of the ring.

Fig. 3 is a side elevation of one embodiment of the invention.

Fig. 4 is a sectional view of the enclosing portion or setting of the ring.

Fig. 5 is a sectional view on the line 5—5 of Fig. 4.

Fig. 6 is an enlarged view showing the cigarette holding device in section.

Fig. 7 is a detail sectional view of the cigarette holder showing the actuating spring for the clamping element.

Fig. 8 is a view similar to Fig. 3, showing in side elevation another form of ring band.

Fig. 9 is a view of the ring shown in Fig. 8 looking toward the right hand side thereof.

The ring shown in Figs. 1, 3 and 4 comprises a bottom wall 1, side walls 2 and 3 and end walls 4 and 5 forming a receptacle or enclosure for the cigarette holding device when the same is not in use. A rod 6 is supported by the walls 2 and 3 near the end wall 4, and a plate 7 is hinged on said rod and actuated outwardly by a spring 8 coiled on the rod. The outer end of the plate 7 is formed with a curved notch 9, the curvature of which conforms generally to a part of the circumference of a cigarette 10, as shown.

A cigarette gripper and ejector is pivoted to the outer end portion of the plate 7, and comprises an arcuate portion 11 formed by shaping a piece of

sheet metal to provide two spaced walls 12 and 13 receiving the plate 7 between them (Fig. 6). The gripper is arcuate so as to fit against a part of the circumference of a cigarette and clamp the same against the notch 9. The gripper is mounted on a pivot 14 and is actuated by a spring 15 to retain the cigarette in the notch 9. For convenience in operation, the gripper is provided with a shoulder 16 to be engaged by the thumb of the hand upon which the ring is mounted so as to raise the gripper to receive a cigarette or to discharge the butt of a smoked cigarette. An arcuate arm 17 extends from the wall 13 and, when the gripper is released from clamping engagement with the cigarette, said arm 17 will eject the cigarette from the holder.

When the plate 7 is extended outwardly for use, it is pressed against the upper margin of the wall 6 by the spring 8 and will be retained in that inclined position so that, when the cigarette is placed in the holder, the end that is ignited extends across and inclines away from the back of the hand, as shown in Fig. 1.

A lid 18 is mounted on a pivot 19 near the wall 5 and has on one side a depending flange 20 formed with an indentation 21 that will receive a projection or spur 22 in connection with the inner side of the wall 2 and thereby hold the closure 18 in closed position. The lid or closure 18, when in latching engagement with the projection or spur 22, will retain the cigarette holder device within the enclosure. The lid 18 has on its free end a pair of opposite extended ears 23 for convenient engagement by a finger or thumb nail to open the lid.

The lid may also be closed even when the cigarette holder is extended to the position shown in Fig. 4, the dimensions of the parts 21 and 22 being sufficient to permit latching engagement to be obtained. This is because the flange 20 can be extended far enough into the enclosure to permit the spur 22 to engage into the indentation 21 even when the cigarette holding device is extended from the enclosure, as shown in Fig. 4.

As shown in Fig. 4, the opposite ends of a coil spring 24 are attached to the rods 6 and 19 and has thereon a series of beads 25. The spring 24, being elastic, adapts the ring to be worn by different persons and on fingers of varying sizes.

The ring shown in Figs. 8 and 9 is of the same construction excepting that the spring 24 and the beads 25 are omitted. Instead, a split resilient ring band 26 is attached to the bottom wall 1 and has its overlapping ends 27 and 28 unat-

tached so that the ring may be worn on fingers of different sizes.

The bottom portion 29 of the ring band shown in Figs. 8 and 9 is flat and of sufficient width to support the ring in an upright position with the cigarette extending upwardly if the ring be placed upon a table or other support.

When the cigarette burns down into proximity with the clamping device, the fire will be extinguished since the cigarette will not burn through the clamp.

From the foregoing, it is apparent that this device makes it most convenient for the wearer to smoke and to carry a burning cigarette, or a cigar, and yet have full use of all of the fingers of the hand on which the ring is worn, all without danger of burning the fingers or bending the cigarette, or the necessity of putting the cigarette down until desired.

It is now apparent that the invention attains all of its intended objects efficiently and satisfactorily. The rings may be made of any ornamental material and configuration. I do not restrict myself unessentially, but what I claim and desire to secure by Letters Patent is:—

1. In a cigarette ring, the combination with an enclosure, of a member having one end pivoted in said enclosure for swinging movements to place said member in said enclosure or to extend said member angularly from said enclosure, a device pivoted to said member and cooperating therewith for holding a cigarette between said device and said member, and means for holding said member in said enclosure.

2. In a cigarette ring, the combination with an enclosure, of a member having one end pivoted in said enclosure for swinging movements to place said member in said enclosure or to extend said member angularly from said enclosure, a device pivoted to said member and cooperating therewith for holding a cigarette between said device and said member, a lid movable to position to hold said member in said enclosure and also movable to position to release said member, and a spring for swinging said member outwardly from said enclosure.

3. In a cigarette ring, the combination with an enclosure, of a clamping member pivoted in one end of said enclosure for swinging movements into said enclosure and to outwardly extended position, a device supported by said clamping member and cooperating therewith to hold a cigarette between said member and said device, and means for holding said clamping device in clamping engagement with a cigarette.

4. In a cigarette ring, the combination with an enclosure, of a clamping member pivoted in one end of said enclosure for swinging movements into said enclosure and to outwardly extended position, a device supported by said clamping member and cooperating therewith to hold a cigarette between said member and said device, means for holding said clamping member and thereby said device in a position for engagement with a cigarette, and means for holding said clamping device in clamping engagement with a cigarette in a position in which the cigarette extends obliquely outwardly with respect to the back of the hand of the wearer of the ring.

5. In a cigarette ring, the combination with an enclosure attached to the ring, of a member having one end pivoted in one end of said enclosure for swinging movements from position in said enclosure to outwardly extended position, and a device pivoted to said member and cooper-

ating therewith to hold a cigarette between said device and said member.

6. In a cigarette ring, the combination with an enclosure attached to the ring, of a member having one end pivoted in said enclosure for swinging movements from within said enclosure to outwardly extended position, and a device pivoted to said member and cooperating therewith to hold a cigarette extended obliquely across and from the hand of the wearer.

7. In a cigarette ring, the combination with an enclosure attached to the ring, of a member having one end pivoted in said enclosure for swinging movements from within said enclosure to outwardly extended position, a device pivoted to said member and cooperating therewith to hold a cigarette extended obliquely across and from the hand of the wearer, and manual means for releasing said device from engagement with the cigarette and for ejecting the cigarette from between said member and said device.

8. The combination with a ring having a flat portion at one side constituting a base for supporting the ring vertically on a support, of an enclosure attached to the opposite side of the ring, a member having one end pivoted in said enclosure for swinging movements of said member into and out of said enclosure, means for swinging said member outwardly from within said enclosure to position at an angle to said enclosure, and means supported by and cooperating with said member to hold a cigarette.

9. The combination with an expansible and contactible ring having a flat portion at one side constituting a base for supporting the ring vertically on a support, of an enclosure attached to the opposite side of the ring, a member having one end pivoted in said enclosure for swinging movements of said member into and out of said enclosure, means for swinging said member outwardly from within said enclosure to position at an angle to said enclosure, a gripper supported by and cooperating with said member to hold a cigarette in position in which the cigarette extends obliquely upwardly from the support on which the ring is mounted, and a spring for actuating said gripper to cooperate with said member as aforesaid.

10. A device of the character described comprising an expansible resilient ring having overlapping unattached ends, an enclosure attached to one side of said ring, a member pivoted in said enclosure for swinging movements from within said enclosure to outwardly extended position, a device pivoted to said member and cooperating therewith to clamp a cigarette between them, means for pressing said device into clamping engagement with a cigarette, and a manually engageable portion on said device for operating the same to release a cigarette.

11. A device of the character described comprising an expansible ring, an enclosure attached to one side of said ring, a member pivoted in said enclosure for swinging movements from within said enclosure to outwardly extended position, a device pivoted to said member and cooperating therewith to clamp a cigarette between them, means for pressing said device into clamping engagement with a cigarette, a manually engageable portion on said device for operating the same to release a cigarette, and means operated by said device for ejecting the cigarette when said device is manually operated as aforesaid.