



US00D688422S

(12) **United States Design Patent**
Berghoff et al.

(10) **Patent No.:** **US D688,422 S**

(45) **Date of Patent:** **** Aug. 20, 2013**

(54) **PET COSTUME**

(75) Inventors: **Jeremy Berghoff**, Chaska, MN (US);
Elyse Sikora, Minneapolis, MN (US)

(73) Assignee: **Target Brands, Inc.**, Minneapolis, MN
(US)

(**) Term: **14 Years**

(21) Appl. No.: **29/430,415**

(22) Filed: **Aug. 24, 2012**

(51) **LOC (9) Cl.** **30-01**

(52) **U.S. Cl.**
USPC **D30/145**

(58) **Field of Classification Search**

USPC D30/145, 144, 151-154; 119/678,
119/850, 673, 702, 712, 792-798, 758, 760,
119/769, 770, 784, 815, 818, 856, 863, 864,
119/905, 907, 802, 857, 865, 725, 771; 52/3;
54/79.4, 79.1, 80.1, 79.2; D3/271.2, 217,
D3/327; 150/154; 36/111; 604/293; 602/79,
602/61

See application file for complete search history.

(56) **References Cited**

U.S. PATENT DOCUMENTS

1,437,255	A *	11/1922	Mallinson	54/79.2
1,612,945	A *	1/1927	Rieck	54/79.2
D142,815	S *	11/1945	Ardmore	D30/145
2,850,860	A *	9/1958	Torell et al.	54/79.2
D188,338	S *	7/1960	Gajda	D30/145
3,248,852	A *	5/1966	Schwartz	54/79.1
3,792,687	A *	2/1974	Ehrman	119/868
4,355,600	A *	10/1982	Zielinski	119/850
4,385,592	A *	5/1983	Goldstein	602/18
D313,676	S *	1/1991	Indursky et al.	D30/145
D361,174	S *	8/1995	Karlen	D30/145
D363,572	S *	10/1995	Obenchain	D30/145
D372,563	S *	8/1996	Waugh, Jr.	D30/145
D373,228	S *	8/1996	Brown	D30/145

D374,315	S *	10/1996	Caditz	D30/145
5,632,235	A *	5/1997	Larsen et al.	119/856
D379,687	S *	6/1997	Curtis	D30/145
D383,255	S *	9/1997	Caditz	D30/145
5,662,640	A *	9/1997	Daniels	604/392
D403,132	S *	12/1998	Campbell-Henderson	..	D30/145
D404,852	S *	1/1999	Powell-Lesnick	D30/145

(Continued)

OTHER PUBLICATIONS

“Caveman Pterodactyl Pet Rider,” www.amazon.com/dp/B003ILGQJ2/ref=asc_df_B003ILGQJ2214131...om92707-20&creative=394997&creativeASIN=B003ILGQJ2&linkCode=asn, available at least as early as Dec. 29, 2011 (3 pages).

(Continued)

Primary Examiner — Susan Moon Lee

(74) *Attorney, Agent, or Firm* — Griffiths & Seaton PLLC;
JoAnn M. Seaton

(57) **CLAIM**

The ornamental design for a pet costume, as shown and described.

DESCRIPTION

FIG. 1 is a front, perspective view of a pet costume showing our new design;

FIG. 2 is a front view thereof;

FIG. 3 is a rear view thereof;

FIG. 4 is a right side view thereof;

FIG. 5 is a left side view thereof; and,

FIG. 6 is a top view thereof.

Broken lines and unshaded portions contained within broken lines are not claimed.

The bolded dot-dash lines are implemented as boundary lines to indicate the border between the extent of unclaimed surface and the start of claimed surface. None of the bottom surfaces of the pet costume are intended to be claimed, and therefore, the bottom view has been omitted from this application.

1 Claim, 5 Drawing Sheets

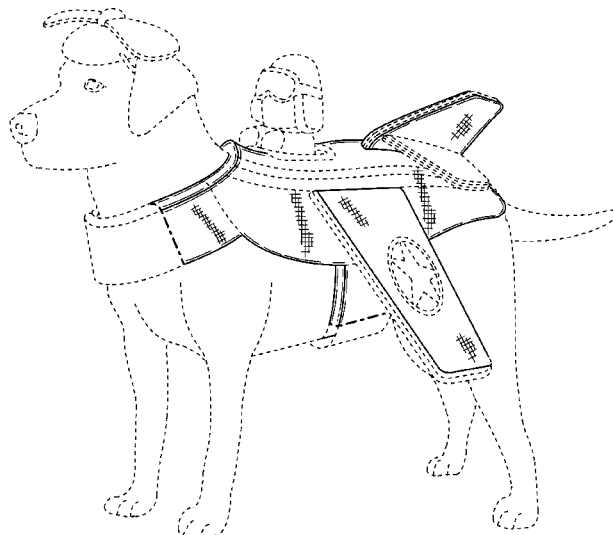

(56)

References Cited

U.S. PATENT DOCUMENTS

D413,186	S	*	8/1999	Brown	D30/145
5,941,199	A	*	8/1999	Tamura	119/850
5,996,537	A	*	12/1999	Caditz	119/850
D427,734	S	*	7/2000	Balzarini	D30/145
6,119,635	A	*	9/2000	Powell-Lesnick	119/850
D441,924	S	*	5/2001	Mann	D30/145
6,267,083	B1	*	7/2001	Chimienti	119/850
D453,594	S	*	2/2002	Ishihara	D30/152
D457,276	S	*	5/2002	Lidis	D30/145
D457,988	S	*	5/2002	Kerrigan	D30/145
D459,842	S	*	7/2002	Kaplan	D30/145
6,443,101	B1	*	9/2002	Fazio	119/792
6,477,988	B2	*	11/2002	Burnett	119/850
D470,275	S	*	2/2003	Lidis	D30/145
6,539,898	B2	*	4/2003	Gatto	119/850
D479,896	S	*	9/2003	Wilson	D30/145
D481,835	S	*	11/2003	Williams	D30/145
6,662,754	B1	*	12/2003	Wilson	119/850
D486,275	S	*	2/2004	Grubb	D30/145
6,694,924	B2	*	2/2004	Clark	119/850
6,694,925	B2	*	2/2004	Critzler	119/850
D511,868	S	*	11/2005	Cherrett	D30/145
D526,452	S	*	8/2006	Crain	D30/145
RE39,564	E	*	4/2007	Brezinski	119/850
D561,410	S	*	2/2008	Katz	D30/145
7,458,339	B1	*	12/2008	Peirano	119/815
D584,862	S	*	1/2009	Kemper	D30/145
D591,460	S	*	4/2009	deCarvalho	D30/145
D606,712	S	*	12/2009	Speed	D30/145
D613,001	S	*	3/2010	O'Brien	D30/145
D634,488	S	*	3/2011	Cohen	D30/145
7,918,192	B1	*	4/2011	Digh et al.	119/850
D637,363	S	*	5/2011	Clement	D30/145
8,015,948	B2	*	9/2011	Hall	119/850
D651,364	S	*	12/2011	Luckenbach	D30/145
D653,410	S	*	1/2012	Morton	D30/152
D654,637	S	*	2/2012	Jansson	D30/145
D656,691	S	*	3/2012	Jansson	D30/145
8,291,867	B2	*	10/2012	Blizzard	119/850
D673,738	S	*	1/2013	Lanzendorf	D30/145
D679,061	S	*	3/2013	Jansson	D30/145
D679,871	S	*	4/2013	Peevey	D30/145
2003/0079695	A1	*	5/2003	Kerrigan	119/858
2003/0221636	A1	*	12/2003	Critzler	119/850
2005/0072376	A1	*	4/2005	Kerrigan	119/850
2005/0229869	A1	*	10/2005	Leo	119/850
2006/0090711	A1	*	5/2006	Richards	119/850
2006/0169221	A1	*	8/2006	Teague	119/850
2007/0289557	A1	*	12/2007	Gerdes	119/850
2007/0289558	A1	*	12/2007	Bonfoey	119/850
2009/0120377	A1	*	5/2009	Palmer	119/856
2010/0043725	A1	*	2/2010	Hall	119/850
2010/0206247	A1	*	8/2010	Cheng et al.	119/850
2010/0319632	A1	*	12/2010	Blizzard	119/850
2011/0155077	A1	*	6/2011	Hurwitz	119/850
2012/0024239	A1	*	2/2012	Forbes	119/850
2013/0014705	A1	*	1/2013	Cho et al.	119/850
2013/0042820	A1	*	2/2013	Blizzard	119/850

OTHER PUBLICATIONS

"Ride On Headless Horseman Dog Costume," <http://www.partycity.com/product/dog+headless+horseman+harness.do>, available at least as early as Dec. 29, 2011 (2 pages).

"Dog Riders Jockey Dog Harness," www.costumediscounters.com/pet-costumes-mascots/dog-cos...=1487603957&%22cagpspn=pla%22&gclid=CP-0vtTK77ECFqce7QodG2wALQ, available at least as early as Dec. 29, 2011 (3 pages).

"Dog Riders Mailman Dog Harness," www.wholesalecostumeclub.com/accessories-and-make-up/pet...AWELAID=764902445&cagpspn=pla&gclid=CKjXuu3K77ECFQP0nAod6REAJA, available at least as early as Dec. 29, 2011 (2 pages).

"Monkey Dog Rider Pet," www.oyacostumes.com/en/Monkey-Dog-Rider-Pet, available at least as early as Dec. 29, 2011 (1 page).

"Dog Harness Rider Goblin Orc Pet Halloween Costume," www.buy.com/prod/dog-harness-rider-goblin-orc-pet-halloween-costume/217292231.html available at least as early as Dec. 29, 2011 (2 pages). Photograph of Alaskan Hoodie Dog Costume, publicly for sale 1 year prior (1 page), Aug. 2011.

* cited by examiner

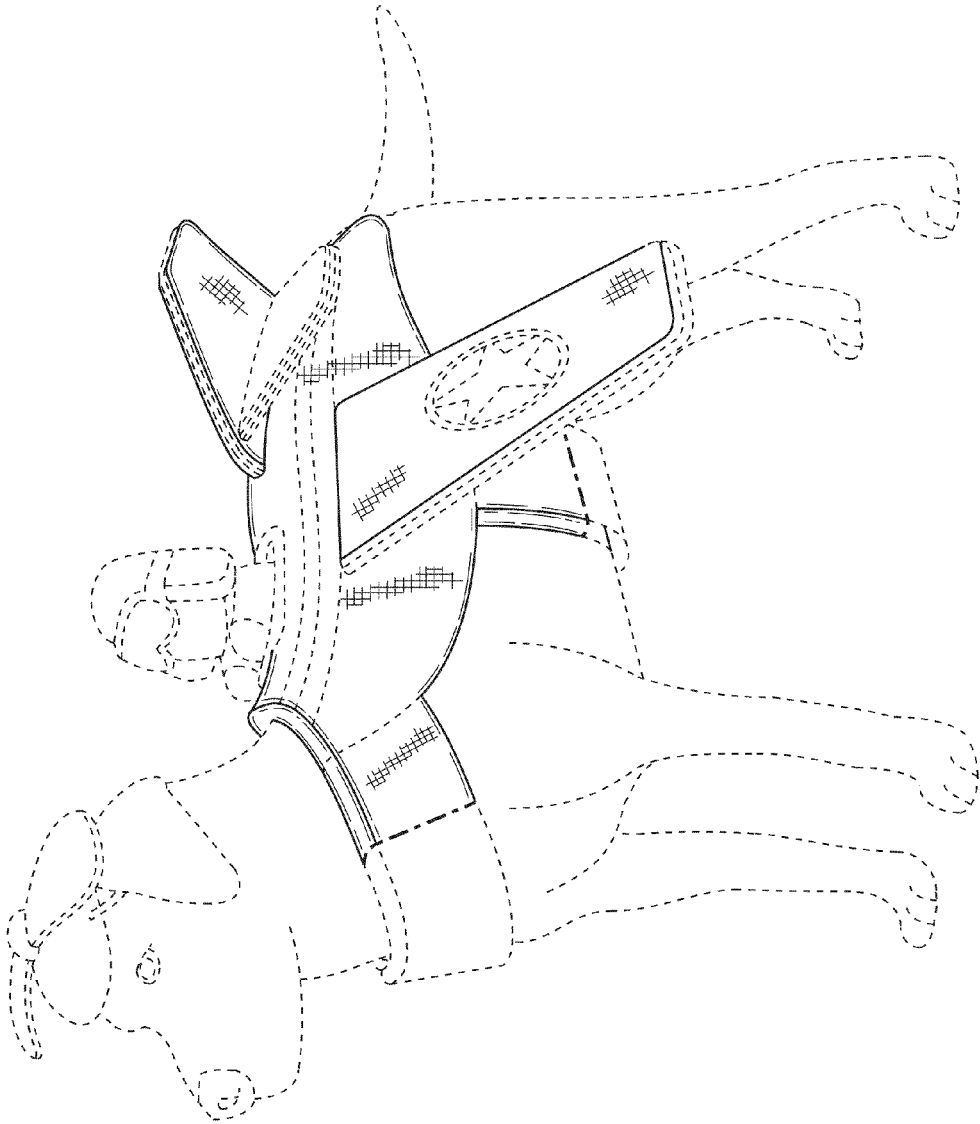

FIG. 1

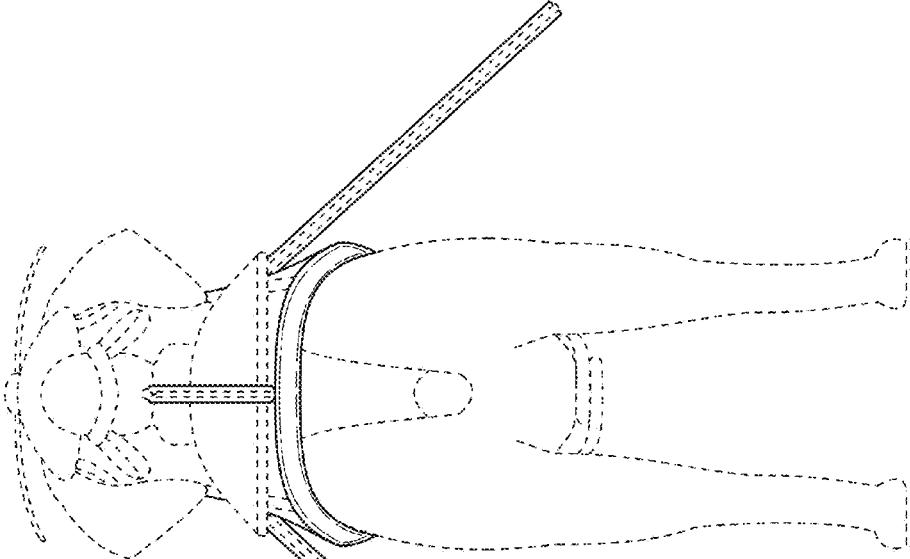

FIG. 2

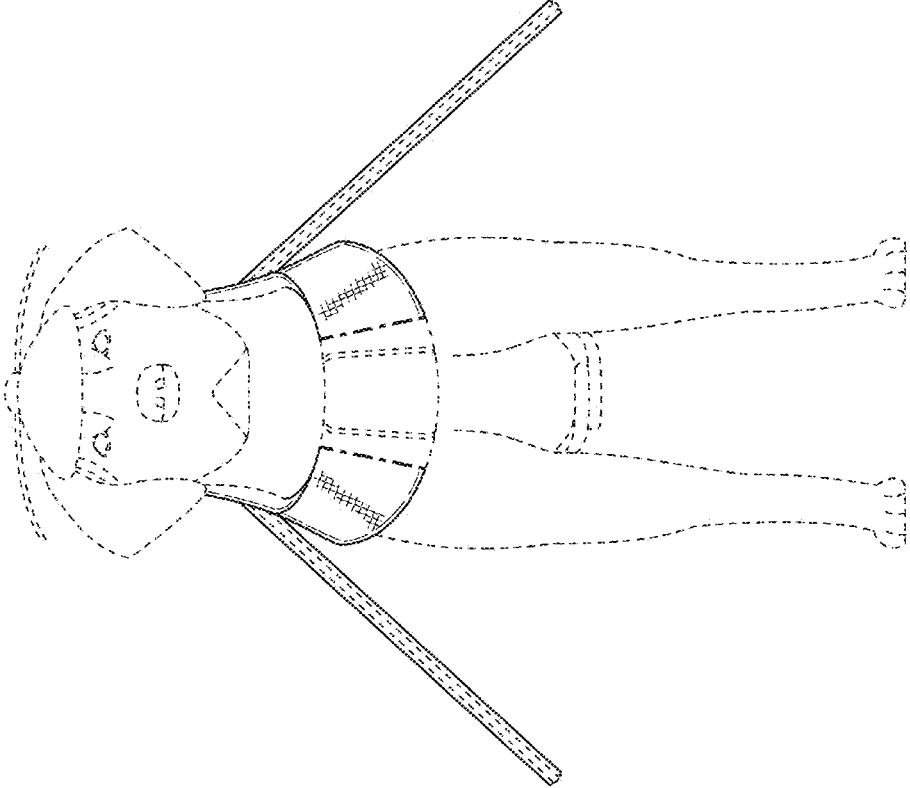

FIG. 3

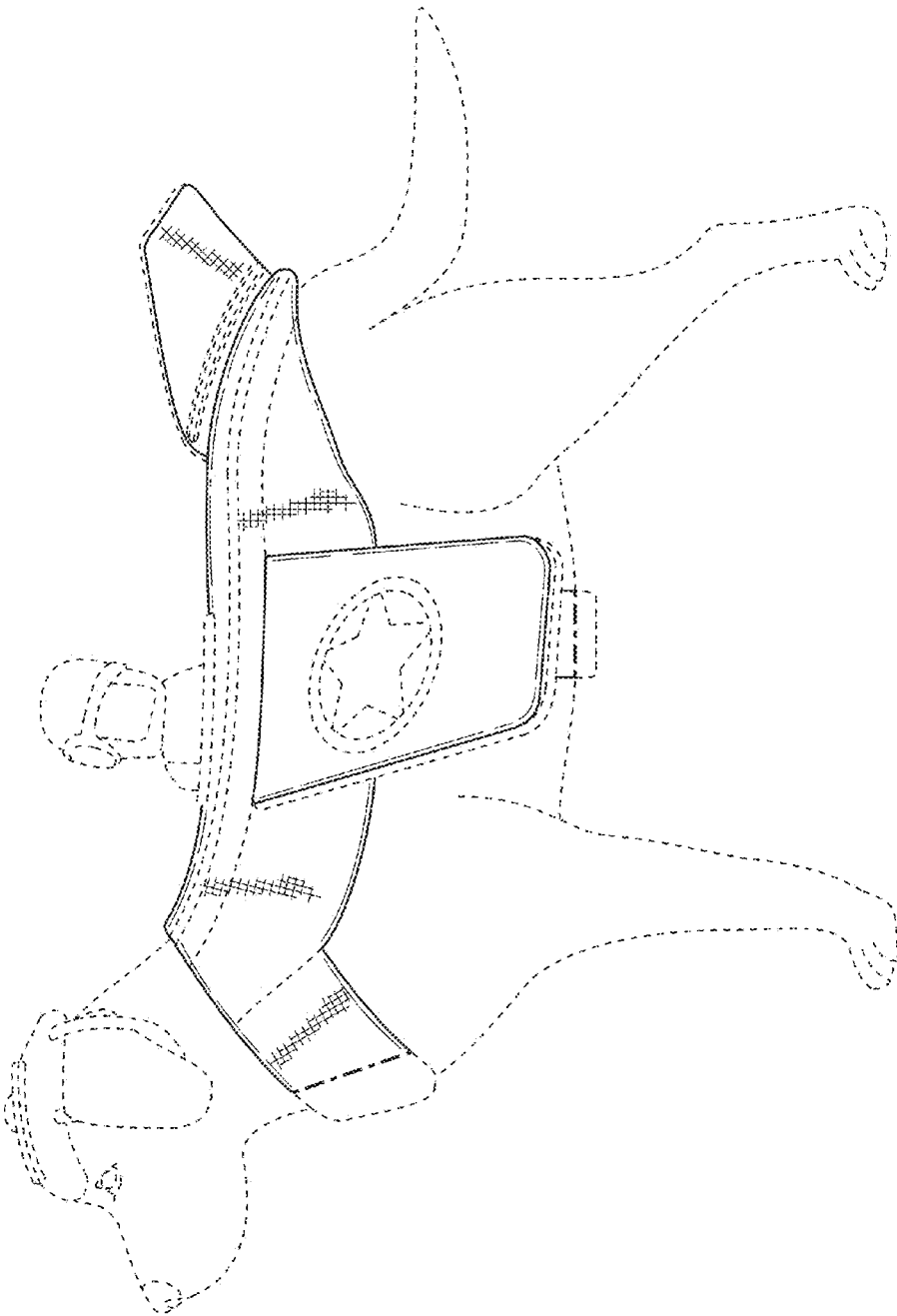

FIG. 4

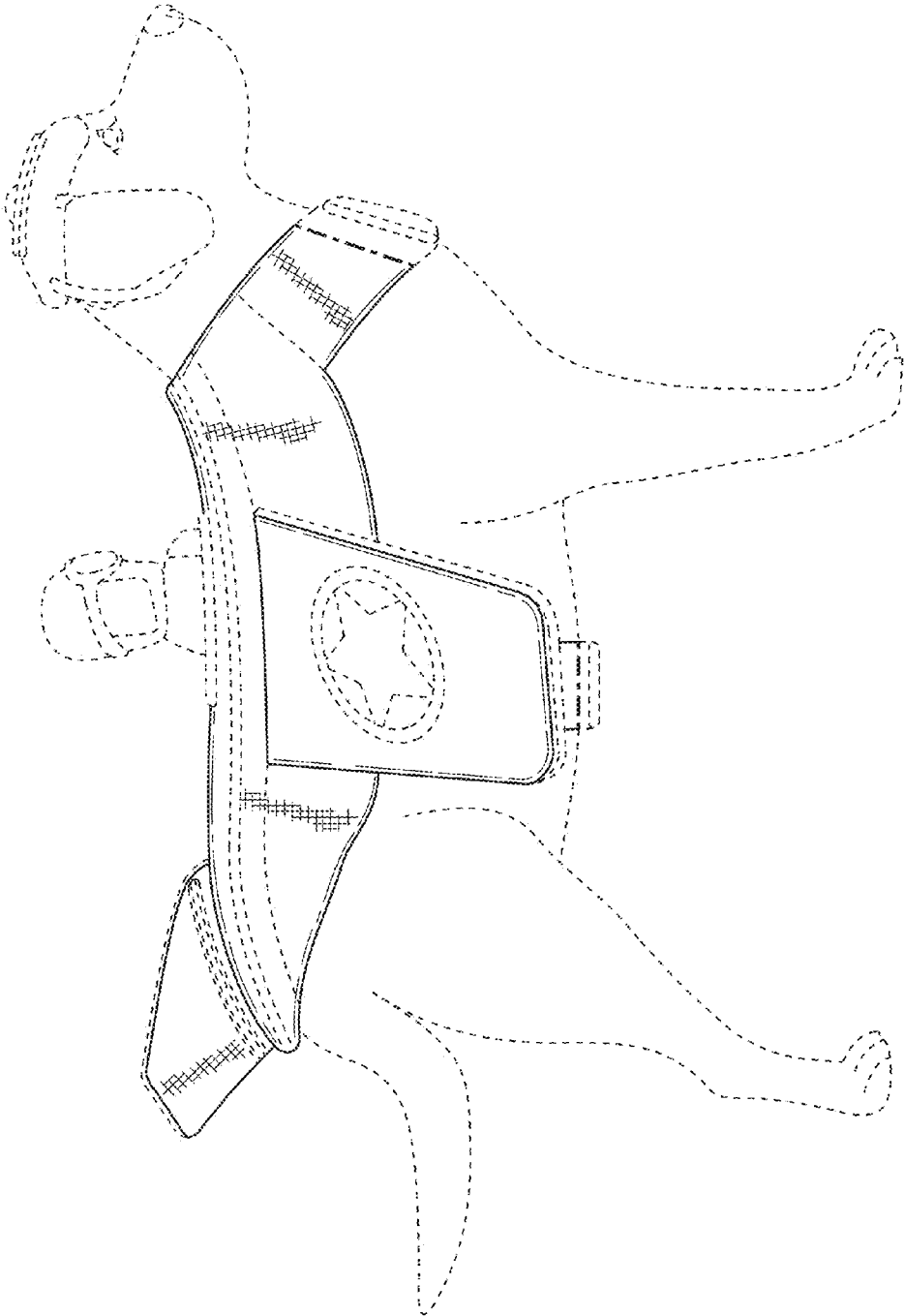

FIG. 5

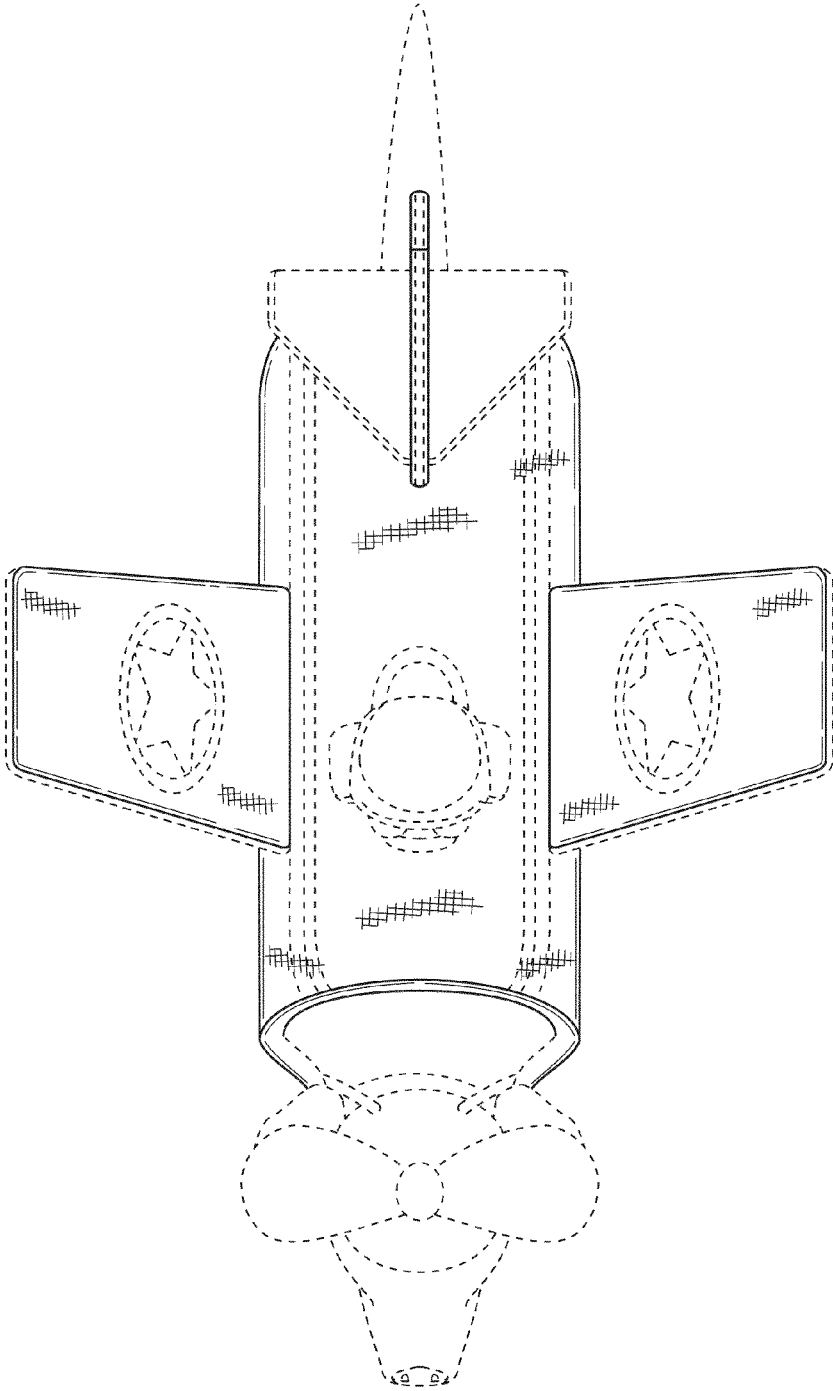

FIG. 6