



(12) **United States Patent**
Honea et al.

(10) **Patent No.:** **US 10,625,125 B2**
(45) **Date of Patent:** ***Apr. 21, 2020**

(54) **GOLF CLUB**

(71) Applicant: **Taylor Made Golf Company, Inc.**,
Carlsbad, CA (US)

(72) Inventors: **Justin Honea**, Richardson, TX (US);
Tim Reed, McKinney, TX (US); **John Kendall**, Wylie, TX (US)

(73) Assignee: **TAYLOR MADE GOLF COMPANY, INC.**,
Carlsbad, CA (US)

(*) Notice: Subject to any disclaimer, the term of this
patent is extended or adjusted under 35
U.S.C. 154(b) by 0 days.

This patent is subject to a terminal dis-
claimer.

(21) Appl. No.: **16/458,916**

(22) Filed: **Jul. 1, 2019**

(65) **Prior Publication Data**
US 2019/0321695 A1 Oct. 24, 2019

Related U.S. Application Data

(63) Continuation of application No. 16/108,299, filed on
Aug. 22, 2018, now Pat. No. 10,335,649, which is a
continuation of application No. 15/632,417, filed on
Jun. 26, 2017, now Pat. No. 10,058,747, which is a
continuation of application No. 14/865,379, filed on
Sep. 25, 2015, now Pat. No. 9,687,700, which is a
continuation of application No. 14/060,948, filed on
Oct. 23, 2013, now Pat. No. 9,168,431, which is a
continuation of application No. 13/716,437, filed on
Dec. 17, 2012, now Pat. No. 8,591,353, which is a
continuation of application No. 13/476,321, filed on
May 21, 2012, now Pat. No. 8,357,058, which is a
continuation of application No. 12/609,209, filed on
Oct. 30, 2009, now Pat. No. 8,206,244, which is a
continuation-in-part of application No. 11/972,368,
filed on Jan. 10, 2008, now Pat. No. 7,632,196.

(51) **Int. Cl.**
A63B 53/04 (2015.01)

(52) **U.S. Cl.**
CPC .. **A63B 53/0466** (2013.01); **A63B 2053/0408**
(2013.01); **A63B 2053/0412** (2013.01); **A63B**
2053/0433 (2013.01); **A63B 2053/0445**
(2013.01)

(58) **Field of Classification Search**
CPC **A63B 53/0466**
USPC **473/324-350**
See application file for complete search history.

(56) **References Cited**

U.S. PATENT DOCUMENTS

411,000 A 9/1889 Anderson
1,133,129 A 3/1915 Govan
(Continued)

FOREIGN PATENT DOCUMENTS

CN 2436182 6/2001
DE 9012884 9/1990
(Continued)

OTHER PUBLICATIONS

Mike Stachura, "The Hot List", Golf Digest Magazine, Feb. 2004,
pp. 82-86.

(Continued)

Primary Examiner — Alvin A Hunter
(74) *Attorney, Agent, or Firm* — Dawsey Co., LPA;
David J. Dawsey

(57) **ABSTRACT**

A golf club having unique mass properties and all the
benefits afforded therefrom.

20 Claims, 22 Drawing Sheets

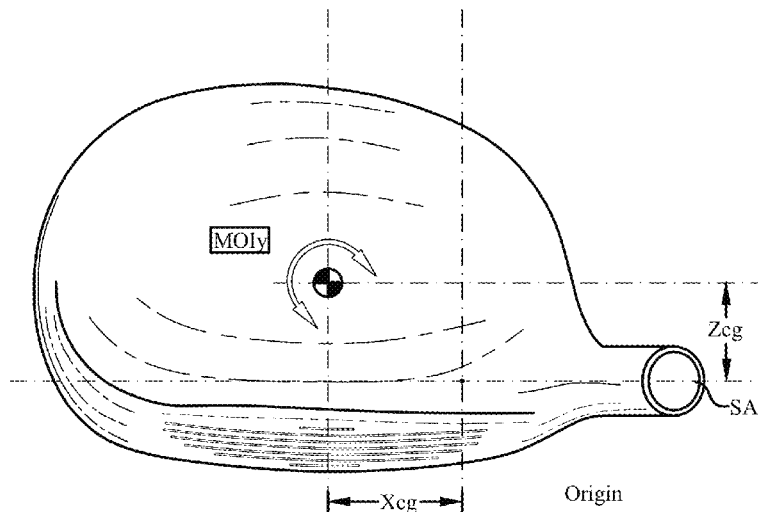

(56)

References Cited

U.S. PATENT DOCUMENTS

1,518,316	A	12/1924	Ellingham	4,867,458	A	9/1989	Sumikawa et al.
1,526,438	A	2/1925	Scott	4,869,507	A	9/1989	Sahn
1,538,312	A	5/1925	Beat	4,881,739	A	11/1989	Garcia
1,592,463	A	7/1926	Marker	4,895,367	A	1/1990	Kajita et al.
1,658,581	A	2/1928	Tobia	4,895,371	A	1/1990	Bushner
1,704,119	A	3/1929	Buhrke	4,915,558	A	4/1990	Muller
1,970,409	A	8/1934	Wiedemann	4,919,428	A	4/1990	Perkins
D107,007	S	11/1937	Cashmore	4,962,932	A	10/1990	Anderson
2,214,356	A	9/1940	Wettlaufer	4,994,515	A	2/1991	Washiyama et al.
2,225,930	A	12/1940	Sexton	5,006,023	A	4/1991	Kaplan
2,360,364	A	10/1944	Reach	5,020,950	A	6/1991	Ladouceur
2,375,249	A	5/1945	Richer	5,028,049	A	7/1991	McKeighen
2,460,435	A	2/1949	Schaffer	5,039,267	A	8/1991	Wollar
2,681,523	A	6/1954	Sellers	5,050,879	A	9/1991	Sun et al.
3,064,980	A	11/1962	Steiner	5,058,895	A	10/1991	Igarashi
3,085,804	A	4/1963	Pieper	5,078,400	A	1/1992	Desbiolles et al.
3,166,320	A	1/1965	Onions	5,092,599	A	3/1992	Okumoto et al.
3,466,047	A	9/1969	Rodia et al.	5,116,054	A	5/1992	Johnson
3,486,755	A	12/1969	Hodge	5,121,922	A	6/1992	Harsh, Sr.
3,556,533	A	1/1971	Hollis	5,122,020	A	6/1992	Bedi
3,589,731	A	6/1971	Chancellor	5,172,913	A	12/1992	Bouquet
3,606,327	A	9/1971	Gorman	5,190,289	A	3/1993	Nagai et al.
3,610,630	A	10/1971	Glover	5,193,810	A	3/1993	Antonious
3,652,094	A	3/1972	Glover	5,221,086	A	6/1993	Antonious
3,672,419	A	6/1972	Fischer	5,244,210	A	9/1993	Au
3,692,306	A	9/1972	Glover	5,251,901	A	10/1993	Solheim et al.
3,743,297	A	7/1973	Dennis	5,253,869	A	10/1993	Dingle et al.
3,893,672	A	7/1975	Schonher	5,255,919	A	10/1993	Johnson
3,897,066	A	7/1975	Belmont	D343,558	S	1/1994	Latraverse et al.
3,976,299	A	8/1976	Lawrence et al.	5,297,794	A	3/1994	Lu
3,979,122	A	9/1976	Belmont	5,301,944	A	4/1994	Koehler
3,979,123	A	9/1976	Belmont	5,316,305	A	5/1994	McCabe
3,985,363	A	10/1976	Jepson et al.	5,318,297	A	6/1994	Davis et al.
3,997,170	A	12/1976	Goldberg	5,320,005	A	6/1994	Hsiao
4,008,896	A	2/1977	Gordos	5,328,176	A	7/1994	Lo
4,043,563	A	8/1977	Churchward	5,340,106	A	8/1994	Ravaris
4,052,075	A	10/1977	Daly	5,346,217	A	9/1994	Tsuchiya et al.
4,065,133	A	12/1977	Gordos	5,385,348	A	1/1995	Wargo
4,076,254	A	2/1978	Nygren	5,395,113	A	3/1995	Antonious
4,077,633	A	3/1978	Studen	5,410,798	A	5/1995	Lo
4,085,934	A	4/1978	Churchward	5,419,556	A	5/1995	Take
4,121,832	A	10/1978	Ebbing	5,421,577	A	6/1995	Kobayashi
4,139,196	A	2/1979	Riley	5,429,365	A	7/1995	McKeighen
4,147,349	A	4/1979	Jeghers	5,439,222	A	8/1995	Kranenberg
4,150,702	A	4/1979	Holmes	5,441,274	A	8/1995	Clay
4,165,076	A	8/1979	Cella	5,447,309	A	9/1995	Vincent
4,189,976	A	2/1980	Becker	5,449,260	A	9/1995	Whittle
4,193,601	A	3/1980	Reid, Jr. et al.	D365,615	S	12/1995	Shimatani
4,214,754	A	7/1980	Zebelean	5,482,280	A	1/1996	Yamawaki
D256,709	S	9/1980	Reid, Jr. et al.	5,511,786	A	4/1996	Antonious
4,247,105	A	1/1981	Jeghers	5,518,243	A	5/1996	Redman
4,262,562	A	4/1981	MacNeill	5,533,730	A	7/1996	Ruvang
D259,698	S	6/1981	MacNeill	5,558,332	A	9/1996	Cook
4,340,229	A	7/1982	Stuff, Jr.	D375,130	S	10/1996	Hlinka et al.
4,411,430	A	10/1983	Dian	5,564,705	A	10/1996	Kobayashi et al.
4,423,874	A	1/1984	Stuff, Jr.	5,571,053	A	11/1996	Lane
4,431,192	A	2/1984	Stuff, Jr.	5,582,553	A	12/1996	Ashcraft et al.
4,438,931	A	3/1984	Motomiya	5,613,917	A	3/1997	Kobayashi et al.
4,489,945	A	12/1984	Kobayashi	D378,770	S	4/1997	Hlinka et al.
4,527,799	A	7/1985	Solheim	5,620,379	A	4/1997	Borys
4,530,505	A	7/1985	Stuff	5,624,331	A	4/1997	Lo et al.
D284,346	S	6/1986	Masters	5,629,475	A	5/1997	Chastonay
4,592,552	A	6/1986	Garber	5,632,694	A	5/1997	Lee
4,602,787	A	7/1986	Sugioka et al.	5,632,695	A	5/1997	Hlinka et al.
4,607,846	A	8/1986	Perkins	5,658,206	A	8/1997	Antonious
4,712,798	A	12/1987	Preato	5,669,827	A	9/1997	Nagamoto
4,730,830	A	3/1988	Tilley	5,683,309	A	11/1997	Reimers
4,736,093	A	4/1988	Braly	5,688,189	A	11/1997	Bland
4,754,974	A	7/1988	Kobayashi	5,695,412	A	12/1997	Cook
4,754,977	A	7/1988	Sahn	5,700,208	A	12/1997	Nelms
4,762,322	A	8/1988	Molitor et al.	5,709,613	A	1/1998	Sheraw
4,787,636	A	11/1988	Honma	5,718,641	A	2/1998	Lin
4,795,159	A	1/1989	Nagamoto	5,720,674	A	2/1998	Galy
4,803,023	A	2/1989	Enomoto et al.	D392,526	S	3/1998	Nicely
4,867,457	A	9/1989	Lowe	5,746,664	A	5/1998	Reynolds, Jr.
				5,755,627	A	5/1998	Yamazaki et al.
				5,759,114	A	6/1998	Bluto et al.
				5,762,567	A	6/1998	Antonious
				5,766,095	A	6/1998	Antonious

(56)

References Cited

U.S. PATENT DOCUMENTS

5,769,737	A	6/1998	Holladay et al.	6,348,014	B1	2/2002	Chiu
5,776,010	A	7/1998	Helmstetter et al.	6,364,788	B1	4/2002	Helmstetter et al.
5,776,011	A	7/1998	Su et al.	6,371,868	B1	4/2002	Galloway et al.
5,785,608	A	7/1998	Collins	6,379,264	B1	4/2002	Forzano
5,788,587	A	8/1998	Tseng	6,379,265	B1	4/2002	Hirakawa et al.
5,798,587	A	8/1998	Lee	6,383,090	B1	5/2002	Odoherly et al.
RE35,955	E	11/1998	Lu	6,386,987	B1	5/2002	Lejeune, Jr.
5,851,160	A	12/1998	Rugge et al.	6,386,990	B1	5/2002	Reyes et al.
5,876,293	A	3/1999	Musty	6,390,933	B1	5/2002	Galloway et al.
5,885,166	A	3/1999	Shiraishi	6,409,612	B1	6/2002	Evans et al.
5,890,971	A	4/1999	Shiraishi	6,425,832	B2	7/2002	Cackett et al.
D409,463	S	5/1999	McMullin	6,434,811	B1	8/2002	Helmstetter et al.
5,908,356	A	6/1999	Nagamoto	6,435,977	B1	8/2002	Helmstetter et al.
5,911,638	A	6/1999	Parente et al.	6,436,142	B1	8/2002	Paes et al.
5,913,735	A	6/1999	Kenmi	6,440,009	B1	8/2002	Guibaud et al.
5,916,042	A	6/1999	Reimers	6,440,010	B1	8/2002	Deshmukh
D412,547	S	8/1999	Fong	6,443,851	B1	9/2002	Liberatore
5,935,019	A	8/1999	Yamamoto	6,458,042	B1	10/2002	Chen
5,935,020	A	8/1999	Stites et al.	6,458,044	B1	10/2002	Vincent et al.
5,941,782	A	8/1999	Cook	6,461,249	B2	10/2002	Liberatore
5,947,840	A	9/1999	Ryan	6,464,598	B1	10/2002	Miller
5,954,595	A	9/1999	Antonious	6,471,604	B2	10/2002	Hocknell et al.
5,967,905	A	10/1999	Nakahara et al.	6,475,101	B2	11/2002	Burrows
5,971,867	A	10/1999	Galy	6,475,102	B2	11/2002	Helmstetter et al.
5,976,033	A	11/1999	Takeda	6,491,592	B2	12/2002	Cackett et al.
5,997,415	A	12/1999	Wood	6,508,978	B1	1/2003	Deshmukh
6,001,029	A	12/1999	Kobayashi	6,514,154	B1	2/2003	Finn
6,015,354	A	1/2000	Ahn et al.	6,524,194	B2	2/2003	McCabe
6,017,177	A	1/2000	Lanham	6,524,197	B2	2/2003	Boone
6,019,686	A	2/2000	Gray	6,524,198	B2	2/2003	Takeda
6,023,891	A	2/2000	Robertson et al.	6,527,649	B1	3/2003	Neher et al.
6,032,677	A	3/2000	Blechman et al.	6,530,847	B1	3/2003	Antonious
6,033,318	A	3/2000	Drajan, Jr. et al.	6,530,848	B2	3/2003	Gillig
6,033,319	A	3/2000	Farrar	6,533,679	B1	3/2003	McCabe et al.
6,033,321	A	3/2000	Yamamoto	6,547,676	B2	4/2003	Cackett et al.
6,048,278	A	4/2000	Meyer et al.	6,558,273	B2	5/2003	Kobayashi et al.
6,056,649	A	5/2000	Imai	6,565,448	B2	5/2003	Cameron
6,062,988	A	5/2000	Yamamoto	6,565,452	B2	5/2003	Helmstetter et al.
6,074,308	A	6/2000	Domas	6,569,029	B1	5/2003	Hamburger
6,077,171	A	6/2000	Yoneyama	6,569,040	B2	5/2003	Bradstock
6,083,115	A	7/2000	King	6,572,489	B2	6/2003	Miyamoto et al.
6,089,994	A	7/2000	Sun	6,575,845	B2	6/2003	Galloway et al.
6,093,113	A	7/2000	Mertens	6,582,323	B2	6/2003	Soracco et al.
6,123,627	A	9/2000	Antonious	6,592,468	B2	7/2003	Vincent et al.
6,146,286	A	11/2000	Masuda	6,602,149	B1	8/2003	Jacobson
6,149,533	A	11/2000	Finn	6,605,007	B1	8/2003	Bissonnette et al.
6,162,132	A	12/2000	Yoneyama	6,607,452	B2	8/2003	Helmstetter et al.
6,162,133	A	12/2000	Peterson	6,612,938	B2	9/2003	Murphey et al.
6,168,537	B1	1/2001	Ezawa	6,616,547	B2	9/2003	Vincent et al.
6,171,204	B1	1/2001	Starry	6,620,056	B2	9/2003	Galloway et al.
6,186,905	B1	2/2001	Kosmatka	6,638,180	B2	10/2003	Tsurumaki
6,190,267	B1	2/2001	Marlowe et al.	6,638,183	B2	10/2003	Takeda
6,193,614	B1	2/2001	Sasamoto et al.	6,641,487	B1	11/2003	Hamburger
6,203,448	B1	3/2001	Yamamoto	6,641,490	B2	11/2003	Ellemor
6,206,789	B1	3/2001	Takeda	6,648,772	B2	11/2003	Vincent et al.
6,206,790	B1	3/2001	Kubica et al.	6,648,773	B1	11/2003	Evans
6,210,290	B1	4/2001	Erickson et al.	6,652,387	B2	11/2003	Liberatore
6,217,461	B1	4/2001	Galy	6,663,504	B2	12/2003	Hocknell et al.
6,238,303	B1	5/2001	Fite	6,663,506	B2	12/2003	Nishimoto et al.
6,244,974	B1	6/2001	Hanberry, Jr.	6,669,571	B1	12/2003	Cameron et al.
6,248,025	B1	6/2001	Murphey et al.	6,669,577	B1	12/2003	Hocknell et al.
6,254,494	B1	7/2001	Hasebe et al.	6,669,578	B1	12/2003	Evans
6,264,414	B1	7/2001	Hartmann et al.	6,669,580	B1	12/2003	Cackett et al.
6,270,422	B1	8/2001	Fisher	6,676,536	B1	1/2004	Jacobson
6,277,032	B1	8/2001	Smith	6,679,786	B2	1/2004	McCabe
6,290,609	B1	9/2001	Takeda	6,716,111	B2	4/2004	Liberatore
6,296,579	B1	10/2001	Robinson	6,716,114	B2	4/2004	Nishio
6,299,547	B1	10/2001	Kosmatka	6,719,510	B2	4/2004	Cobzaru
6,306,048	B1	10/2001	McCabe et al.	6,719,641	B2	4/2004	Dabbs et al.
6,325,728	B1	12/2001	Helmstetter et al.	6,719,645	B2	4/2004	Kouno
6,334,817	B1	1/2002	Ezawa et al.	6,723,002	B1	4/2004	Barlow
6,338,683	B1	1/2002	Kosmatka	6,739,982	B2	5/2004	Murphy et al.
6,340,337	B2	1/2002	Hasebe et al.	6,739,983	B2	5/2004	Helmstetter et al.
6,348,012	B1	2/2002	Erickson et al.	6,743,118	B1	6/2004	Soracco
6,348,013	B1	2/2002	Kosmatka	6,749,523	B1	6/2004	Forzano
				6,757,572	B1	6/2004	Forest
				6,758,763	B2	7/2004	Murphy et al.
				6,773,359	B1	8/2004	Lee
				6,773,360	B2	8/2004	Willett et al.

(56)

References Cited

U.S. PATENT DOCUMENTS

			7,377,860 B2	5/2008	Breier et al.	
			7,390,266 B2	6/2008	Gwon	
			7,407,447 B2	8/2008	Beach et al.	
			7,419,441 B2	9/2008	Hoffman et al.	
			7,448,963 B2	11/2008	Beach et al.	
6,773,361 B1	8/2004	Lee	7,500,924 B2	3/2009	Yokota	
6,776,726 B2	8/2004	Sano	7,520,820 B2	4/2009	Dimarco	
6,800,038 B2	10/2004	Willett et al.	7,530,901 B2	5/2009	Imamoto et al.	
6,800,040 B2	10/2004	Galloway et al.	7,530,904 B2	5/2009	Beach et al.	
6,805,643 B1	10/2004	Lin	7,540,811 B2	6/2009	Beach et al.	
6,808,460 B2	10/2004	Namiki	7,563,175 B2	7/2009	Nishitani et al.	
6,824,475 B2	11/2004	Burnett et al.	7,568,985 B2	8/2009	Beach et al.	
6,835,145 B2	12/2004	Tsurumaki	7,572,193 B2	8/2009	Yokota	
6,855,068 B2	2/2005	Antonious	7,578,753 B2	8/2009	Beach et al.	
6,860,818 B2	3/2005	Mahaffey et al.	7,582,024 B2	9/2009	Shear	
6,860,823 B2	3/2005	Lee	7,591,737 B2	9/2009	Gibbs et al.	
6,860,824 B2	3/2005	Evans	7,591,738 B2	9/2009	Beach et al.	
6,875,124 B2	4/2005	Gilbert et al.	7,621,823 B2	11/2009	Beach et al.	
6,875,129 B2	4/2005	Erickson et al.	7,632,196 B2 *	12/2009	Reed	A63B 53/0466
6,875,130 B2	4/2005	Nishio				473/324
6,881,158 B2	4/2005	Yang et al.	8,206,244 B2 *	6/2012	Honea	A63B 53/0466
6,881,159 B2	4/2005	Galloway et al.				473/345
6,887,165 B2	5/2005	Tsurumaki	8,357,058 B2 *	1/2013	Honea	A63B 53/0466
6,890,267 B2	5/2005	Mahaffey et al.				473/345
6,902,497 B2	6/2005	Deshmukh et al.	8,591,353 B1 *	11/2013	Honea	A63B 53/0466
6,904,663 B2	6/2005	Willett et al.				473/345
6,923,734 B2	8/2005	Meyer				473/345
6,926,619 B2	8/2005	Helmstetter et al.	9,168,431 B2 *	10/2015	Honea	A63B 53/0466
6,960,142 B2	11/2005	Bissonnette et al.	10,058,747 B2 *	8/2018	Honea	A63B 53/0466
6,964,617 B2	11/2005	Williams	10,335,649 B2 *	7/2019	Honea	A63B 53/0466
6,974,393 B2	12/2005	Caldwell et al.	2001/0049310 A1	12/2001	Cheng et al.	
6,988,960 B2	1/2006	Mahaffey et al.	2002/0022535 A1	2/2002	Takeda	
6,991,558 B2	1/2006	Beach et al.	2002/0032075 A1	3/2002	Vatsvog	
D515,165 S	2/2006	Zimmerman et al.	2002/0055396 A1	5/2002	Nishimoto et al.	
6,994,636 B2	2/2006	Hocknell et al.	2002/0072434 A1	6/2002	Yabu	
6,997,820 B2	2/2006	Willett et al.	2002/0123394 A1	9/2002	Tsurumaki	
7,004,849 B2	2/2006	Cameron	2002/0137576 A1	9/2002	Dammen	
7,004,852 B2	2/2006	Billings	2002/0160854 A1	10/2002	Beach et al.	
7,025,692 B2	4/2006	Erickson et al.	2002/0183130 A1	12/2002	Pacinella	
7,029,403 B2	4/2006	Rice et al.	2003/0032500 A1	2/2003	Nakahara et al.	
7,070,512 B2	7/2006	Nishio	2003/0130059 A1	7/2003	Billings	
7,070,517 B2	7/2006	Cackett et al.	2003/0220154 A1	11/2003	Anelli	
7,077,762 B2	7/2006	Kouno et al.	2004/0087388 A1	5/2004	Beach et al.	
7,097,572 B2	8/2006	Yabu	2004/0157678 A1	8/2004	Kohno	
7,101,289 B2	9/2006	Gibbs et al.	2004/0176183 A1	9/2004	Tsurumaki	
7,137,906 B2	11/2006	Tsunoda et al.	2004/0192463 A1	9/2004	Tsurumaki et al.	
7,137,907 B2	11/2006	Gibbs et al.	2004/0235584 A1	11/2004	Chao et al.	
7,140,974 B2	11/2006	Chao et al.	2004/0242343 A1	12/2004	Chao et al.	
7,144,334 B2	12/2006	Ehlers et al.	2005/0101404 A1	5/2005	Long et al.	
7,147,573 B2	12/2006	Dimarco	2005/0137024 A1	6/2005	Stites et al.	
7,153,220 B2	12/2006	Lo	2005/0181884 A1	8/2005	Beach et al.	
7,163,468 B2	1/2007	Gibbs et al.	2005/0239575 A1	10/2005	Chao et al.	
7,163,470 B2	1/2007	Galloway et al.	2005/0239576 A1	10/2005	Stites et al.	
7,166,038 B2	1/2007	Williams et al.	2006/0009305 A1	1/2006	Lindsay	
7,166,040 B2	1/2007	Hoffman et al.	2006/0035722 A1	2/2006	Beach et al.	
7,166,041 B2	1/2007	Evans	2006/0058112 A1	3/2006	Haralason et al.	
7,169,058 B1	1/2007	Fagan	2006/0094535 A1	5/2006	Cameron	
7,169,060 B2	1/2007	Stevens et al.	2006/0122004 A1	6/2006	Chen et al.	
7,179,034 B2	2/2007	Ladouceur	2006/0154747 A1	7/2006	Beach	
7,186,190 B1	3/2007	Beach et al.	2006/0172821 A1	8/2006	Evans et al.	
7,189,169 B2	3/2007	Billings	2006/0240908 A1	10/2006	Adams et al.	
7,198,575 B2	4/2007	Beach et al.	2006/0281581 A1	12/2006	Yamamoto	
7,201,669 B2	4/2007	Stites et al.	2007/0026961 A1	2/2007	Hou	
D543,600 S	5/2007	Oldknow	2007/0049417 A1	3/2007	Shear	
7,211,005 B2	5/2007	Lindsay	2007/0105646 A1	5/2007	Beach et al.	
7,214,143 B2	5/2007	Deshmukh	2007/0105647 A1	5/2007	Beach et al.	
7,223,180 B2	5/2007	Willett et al.	2007/0105648 A1	5/2007	Beach et al.	
D544,939 S	6/2007	Radcliffe et al.	2007/0105649 A1	5/2007	Beach et al.	
7,252,600 B2	8/2007	Murphy et al.	2007/0105650 A1	5/2007	Beach et al.	
7,255,654 B2	8/2007	Murphy et al.	2007/0105651 A1	5/2007	Beach et al.	
7,267,620 B2	9/2007	Chao et al.	2007/0105652 A1	5/2007	Beach et al.	
7,273,423 B2	9/2007	Imamoto	2007/0105653 A1	5/2007	Beach et al.	
7,278,927 B2	10/2007	Gibbs et al.	2007/0105654 A1	5/2007	Beach et al.	
7,281,985 B2	10/2007	Galloway	2007/0105655 A1	5/2007	Beach et al.	
D554,720 S	11/2007	Barez et al.	2007/0117652 A1	5/2007	Beach et al.	
7,291,074 B2	11/2007	Kouno et al.	2007/0275792 A1	11/2007	Horacek et al.	
7,294,064 B2	11/2007	Tsurumaki et al.	2008/0146370 A1	6/2008	Beach et al.	
7,294,065 B2	11/2007	Liang et al.	2008/0161127 A1	7/2008	Yamamoto	
7,303,488 B2	12/2007	Kakiuchi et al.	2008/0254911 A1	10/2008	Beach et al.	
7,306,527 B2	12/2007	Williams et al.	2008/0261717 A1	10/2008	Hoffman et al.	

(56)

References Cited

U.S. PATENT DOCUMENTS

2008/0280698 A1 11/2008 Hoffman et al.
 2009/0088269 A1 4/2009 Beach et al.
 2009/0088271 A1 4/2009 Beach et al.
 2009/0137338 A1 5/2009 Kajita
 2009/0170632 A1 7/2009 Beach et al.
 2009/0181789 A1 7/2009 Reed et al.
 2010/0048316 A1* 2/2010 Honea A63B 53/0466
 473/282
 2012/0225735 A1 9/2012 Honea et al.
 2017/0291079 A1* 10/2017 Honea A63B 53/0466

FOREIGN PATENT DOCUMENTS

EP 0470488 3/1995
 EP 0617987 11/1997
 EP 1001175 5/2000
 GB 194823 12/1921
 JP 03049777 A 3/1991
 JP 03151988 A 6/1991
 JP 4180778 6/1992
 JP 05317465 12/1993
 JP 06126004 5/1994
 JP 06182004 A 7/1994
 JP 06238022 8/1994
 JP 06285186 A 10/1994
 JP 6304271 11/1994
 JP 08117365 A 5/1996
 JP 09028844 2/1997
 JP 09308717 12/1997
 JP 09327534 12/1997
 JP 2773009 7/1998
 JP 10234902 9/1998
 JP 10277187 10/1998
 JP 2000014841 1/2000
 JP 2000167089 A 6/2000
 JP 2000288131 A 10/2000
 JP 2000300701 A 10/2000
 JP 2000342721 A 12/2000
 JP 2001054595 2/2001
 JP 2001170225 6/2001
 JP 2001204856 7/2001
 JP 2001231888 A 8/2001
 JP 2001346918 12/2001
 JP 2002003969 1/2002
 JP 2002017910 1/2002
 JP 2002052099 2/2002
 JP 2002248183 9/2002
 JP 2002253706 9/2002
 JP 2003038691 2/2003

JP 2003126311 5/2003
 JP 2003226952 8/2003
 JP 2004174224 6/2004
 JP 2004183058 7/2004
 JP 2004222911 8/2004
 JP 2004267438 9/2004
 JP 2005028170 2/2005
 JP 05296582 10/2005
 JP 05323978 11/2005
 JP 2006320493 11/2006
 JP 4128970 7/2008
 JP 2009000281 1/2009
 WO WO8802642 4/1988
 WO WO0166199 9/2001
 WO WO02062501 8/2002
 WO WO03061773 7/2003
 WO WO2004043549 5/2004

OTHER PUBLICATIONS

Mike Stachura, "The Hot List", Golf Digest Magazine, Feb. 2005, pp. 120-130.
 Mike Stachura, "The Hot List", Golf Digest Magazine, Feb. 2005, pp. 131-143.
 Mike Stachura, "The Hot List", Golf Digest Magazine, Feb. 2006, pp. 122-132.
 Mike Stachura, "The Hot List", Golf Digest Magazine, Feb. 2006, pp. 133-143.
 Mike Stachura, "The Hot List", Golf Digest Magazine, Feb. 2007, pp. 130-151.
 "The Hot List", Golf Digest Magazine, Feb. 2008, pp. 114-139.
 "The Hot List", Golf Digest Magazine, Feb. 2009, pp. 101-127.
 Callaway Golf, World's Straightest Driver: FT-i Driver downloaded from www.callawaygolf.com/ft%2Di/driver.aspx?lang=en on Apr. 5, 2007.
 Jackson, Jeff, The Modern Guide to Golf Clubmaking, Ohio: Dynacraft Golf Products, Inc., copyright 1994, p. 237.
 Nike Golf, Sasquatch 460, downloaded from www.nike.com/nikegolf/index.htm on Apr. 5, 2007.
 Nike Golf, Sasquatch Sumo Squared Driver, downloaded from www.nike.com/nikegolf/index.htm on Apr. 5, 2007.
 Taylor Made Golf Company, Inc. Press Release, Burner Fairway Wood, www.tmag.com/media/pressreleases/2007/011807_burner_fairway_rescue.html, Jan. 26, 2007.
 Taylor Made Golf Company Inc., R7 460 Drivers, downloaded from www.taylormadegolf.com/product_detail.asp?pID=14section=overview on Apr. 5, 2007.
 Titleist 907D1, downloaded from www.tees2greens.com/forum/Uploads/Images/7ade3521-192b-4611-870b-395d.jpg on Feb. 1, 2007.

* cited by examiner

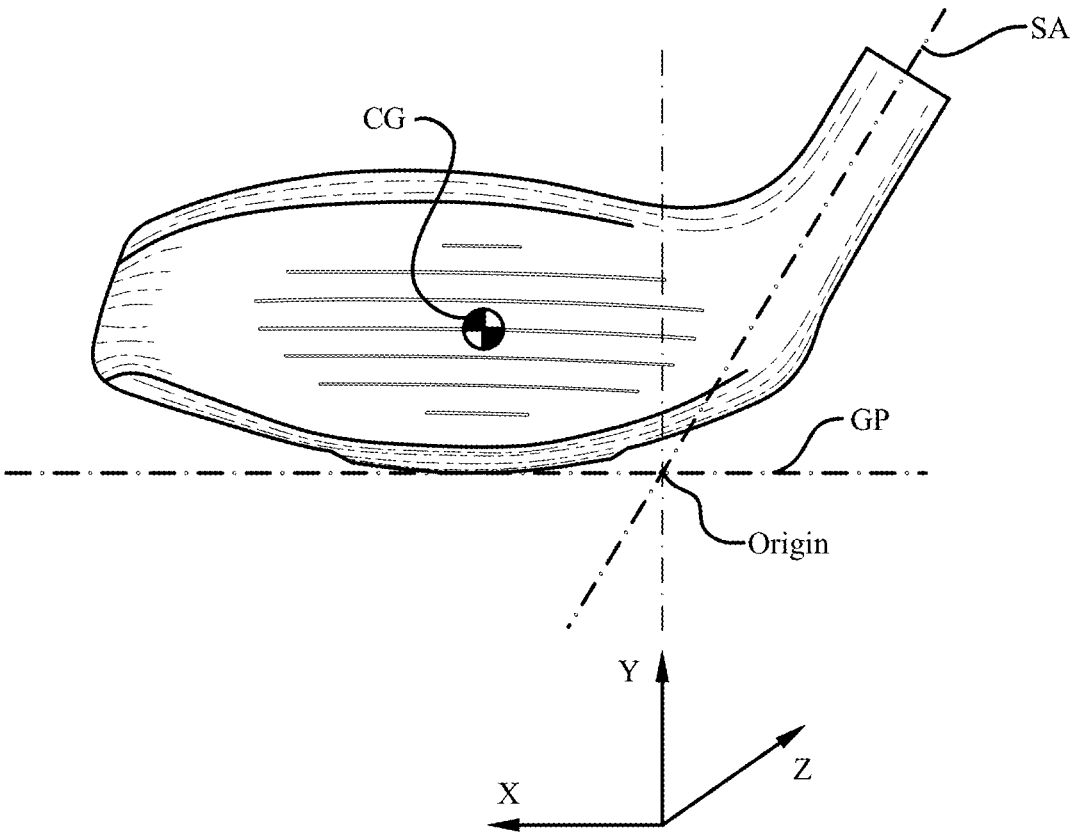

Fig. 1

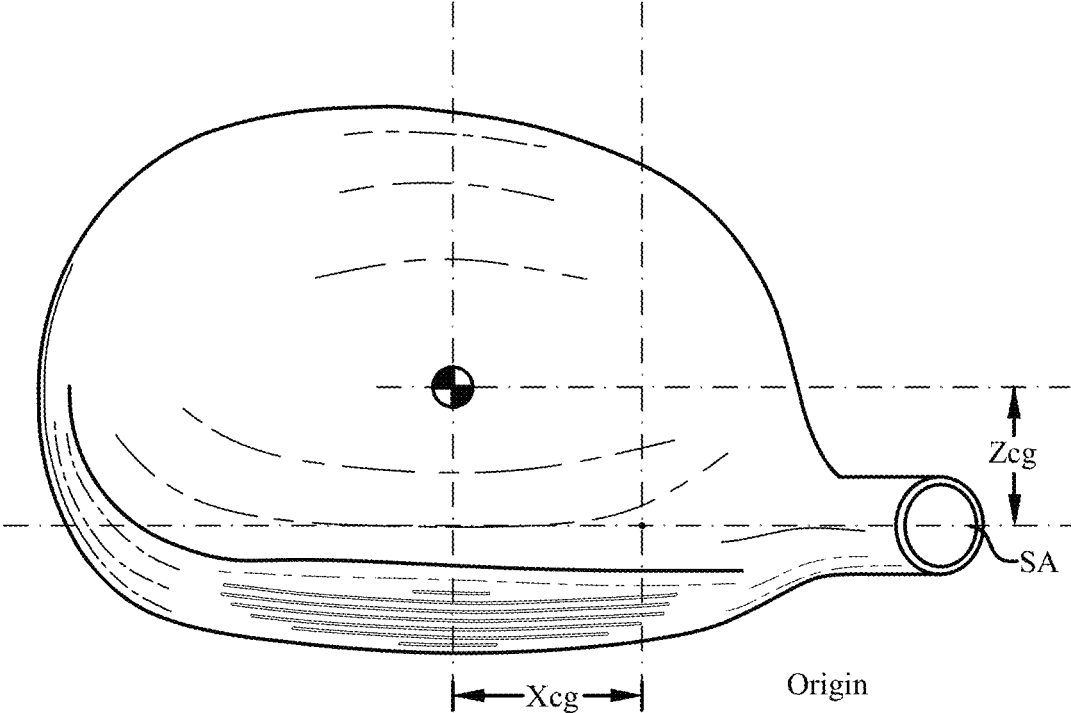

Fig. 2

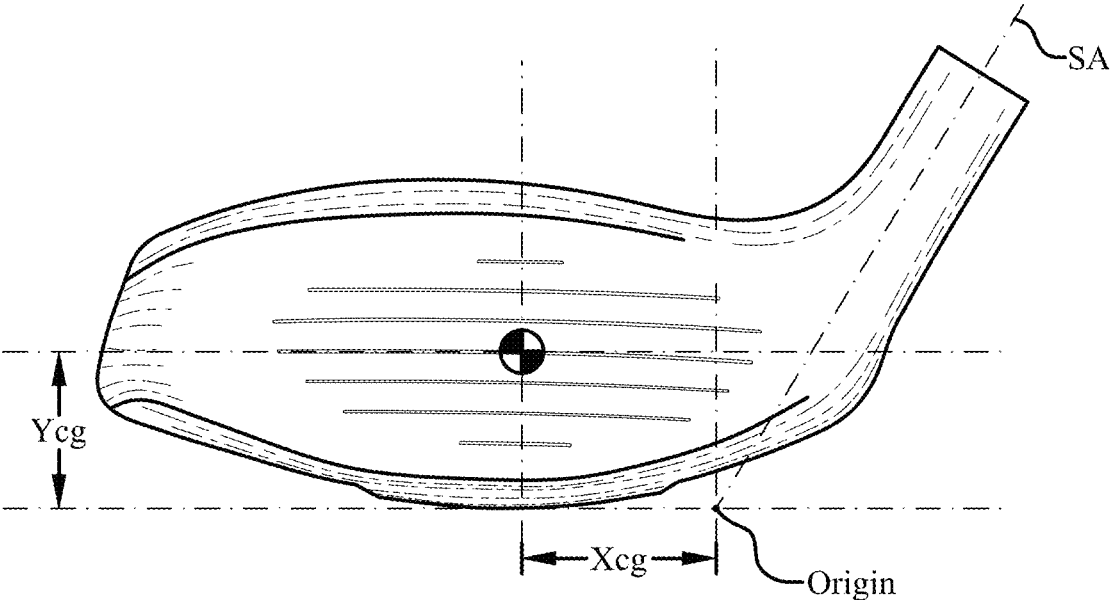

Fig. 3

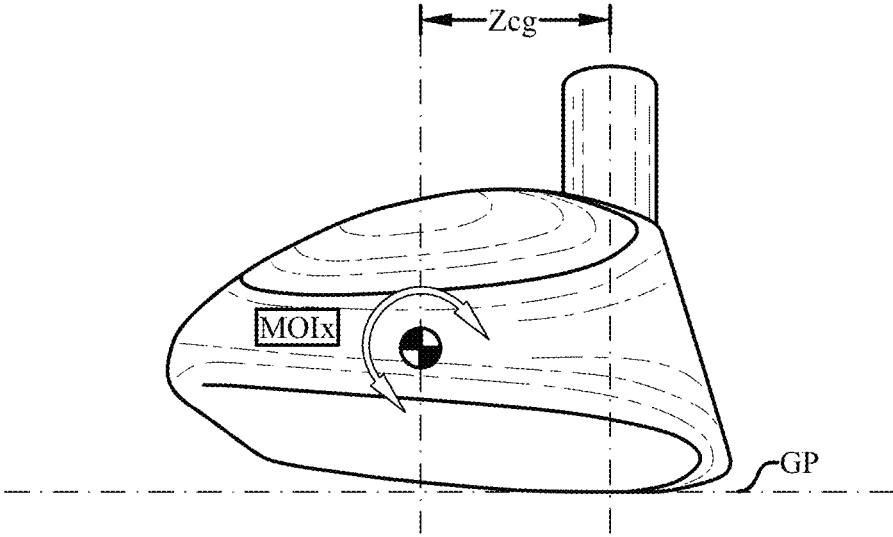

Fig. 4

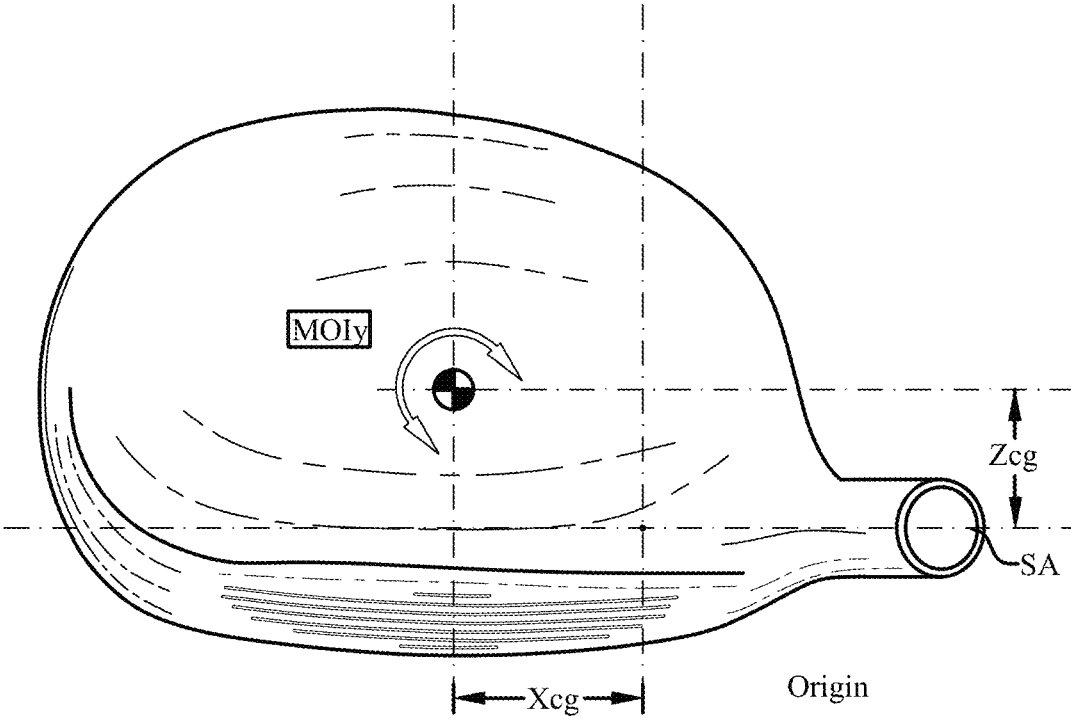

Fig. 5

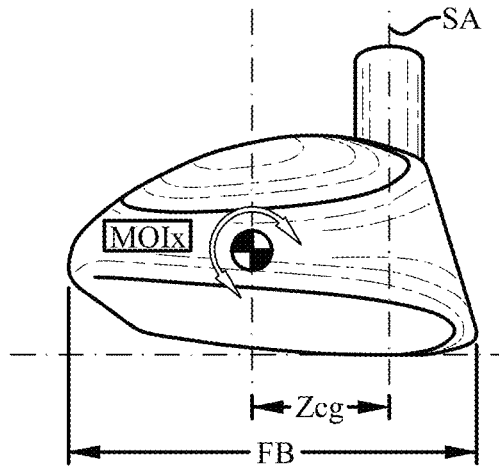

Fig. 6

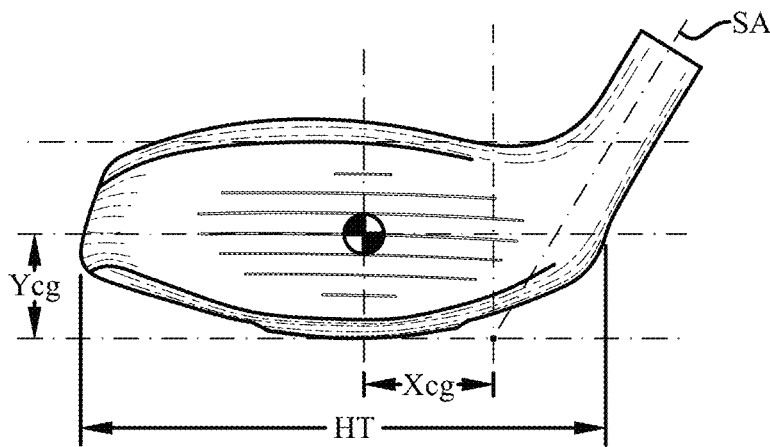

Fig. 7

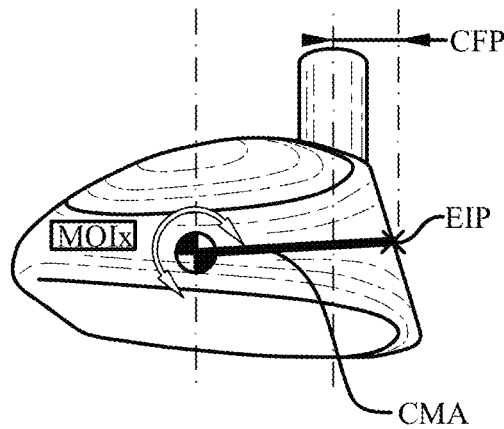

Fig. 8

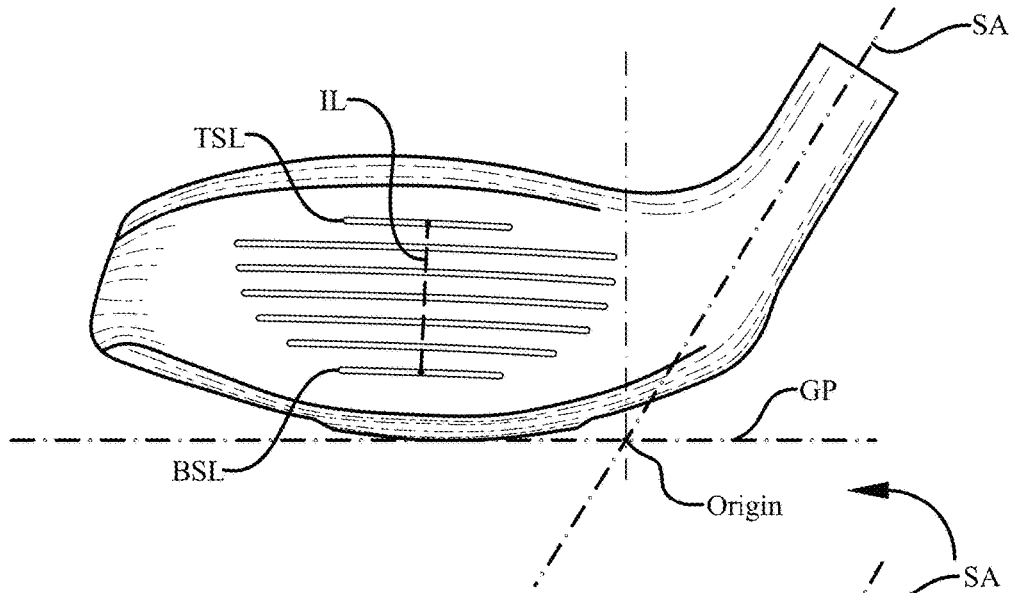

Fig. 9

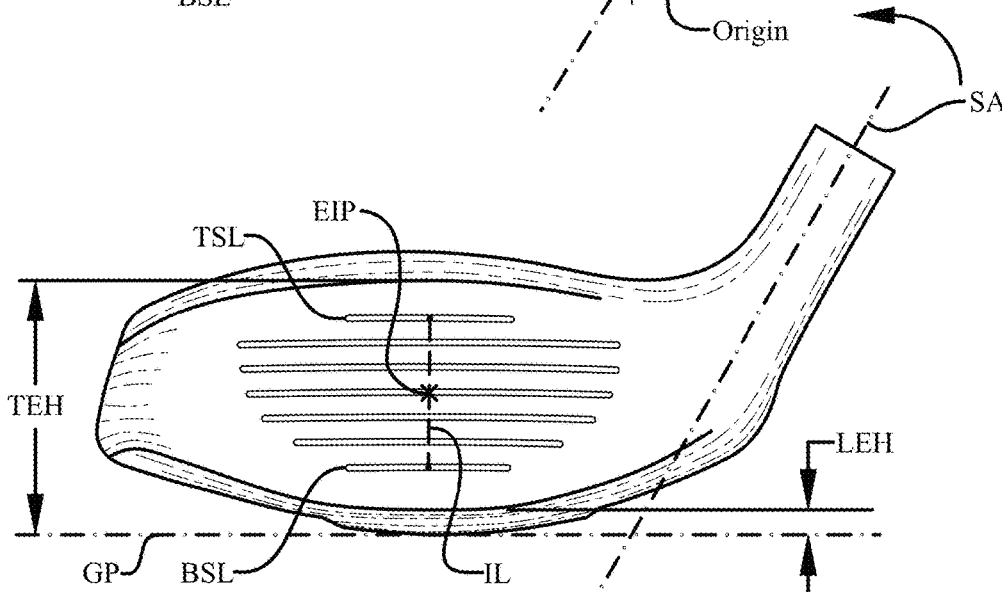

Fig. 10

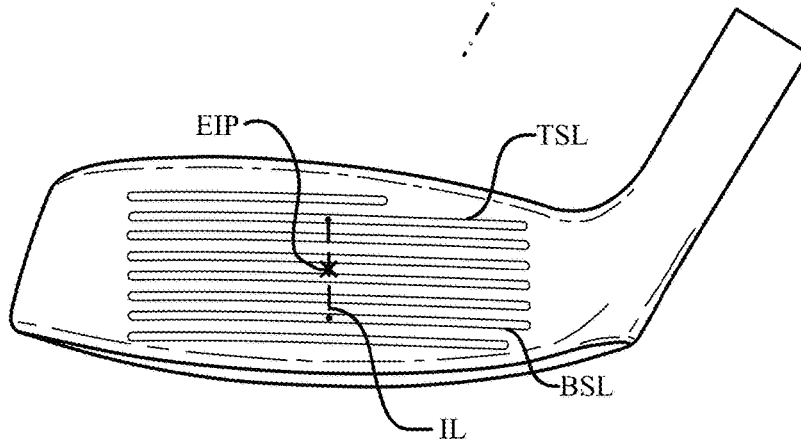

Fig. 11

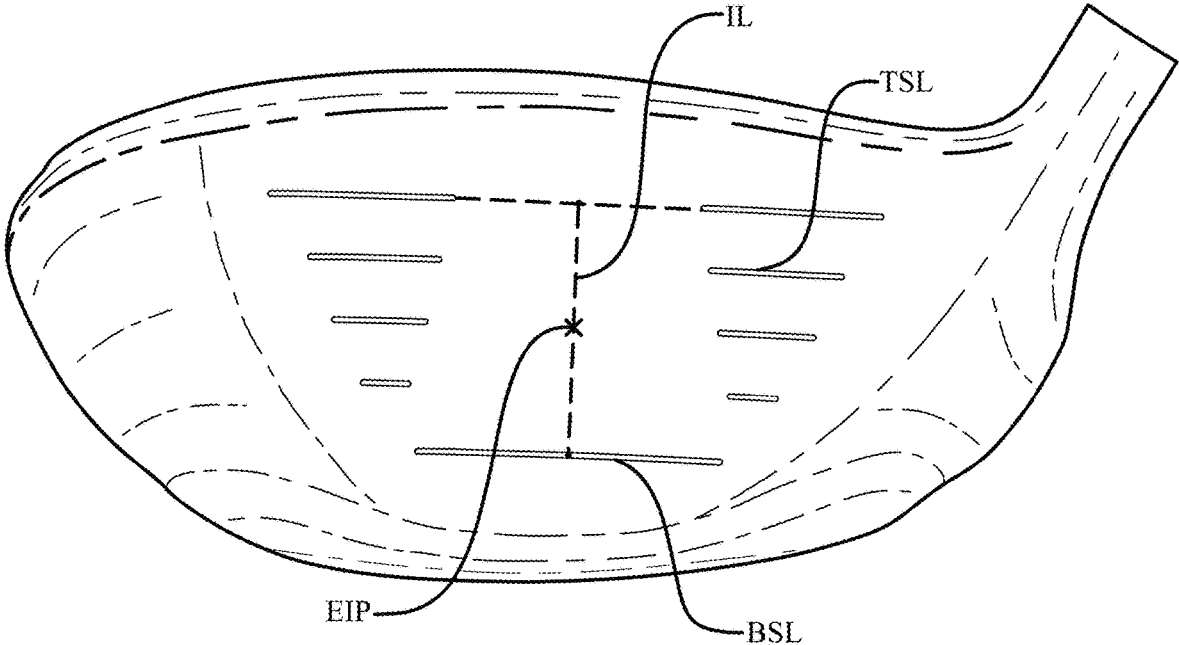
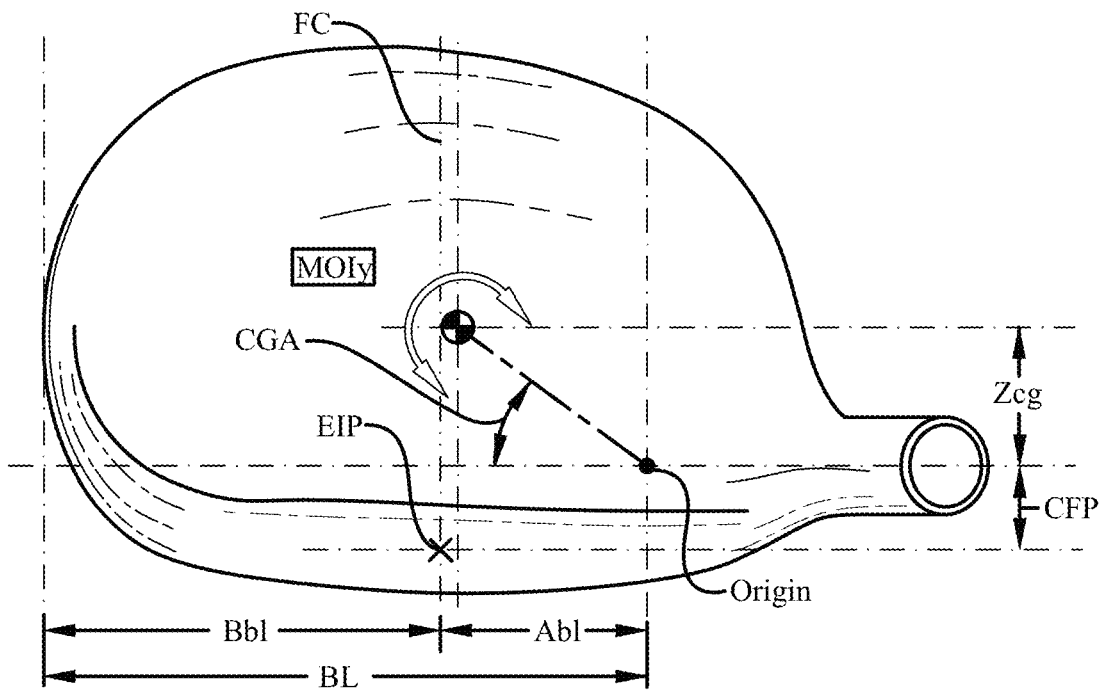
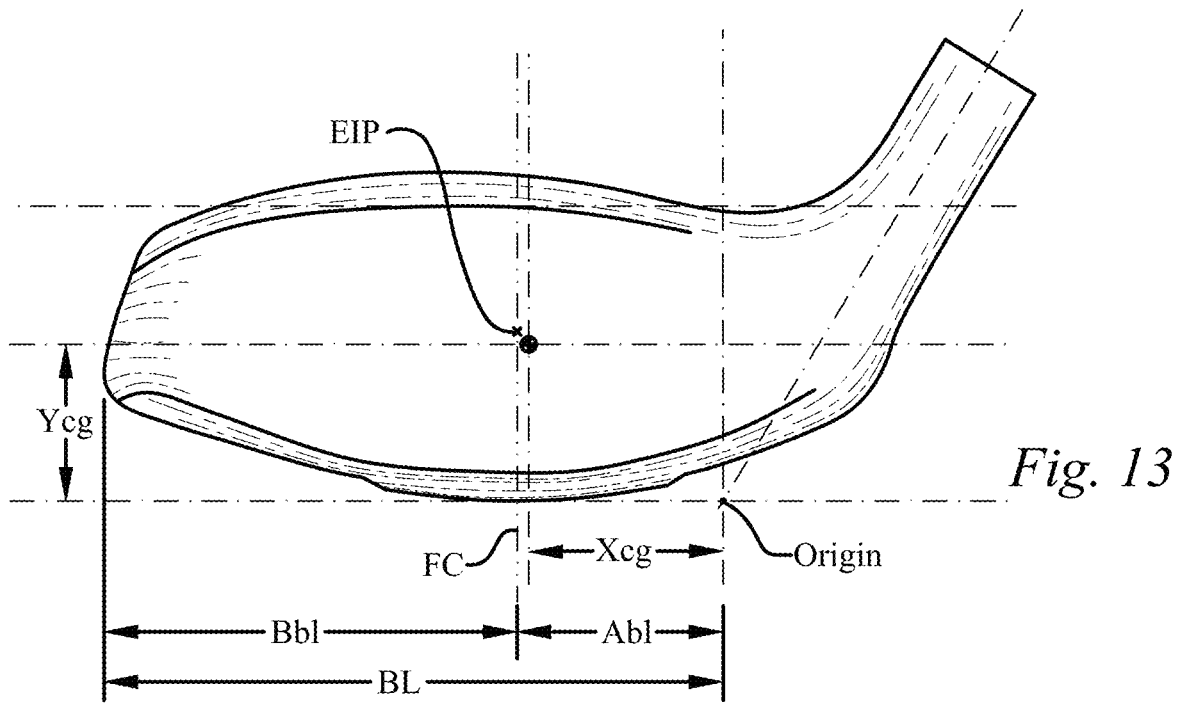

Fig. 12



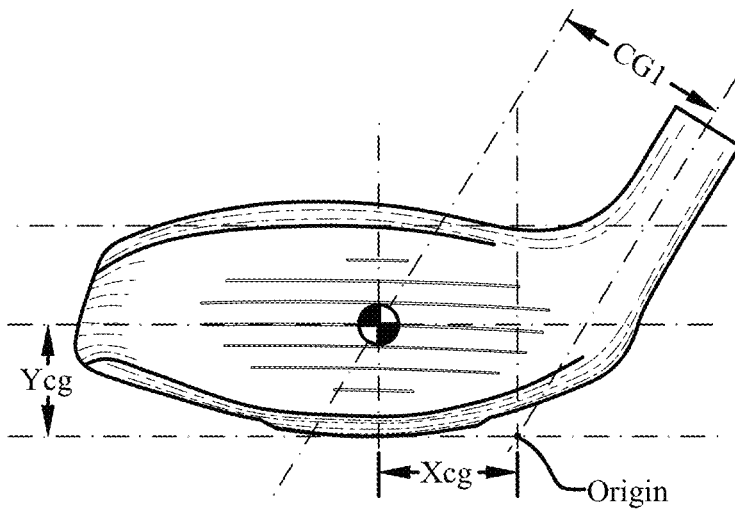

Fig. 15

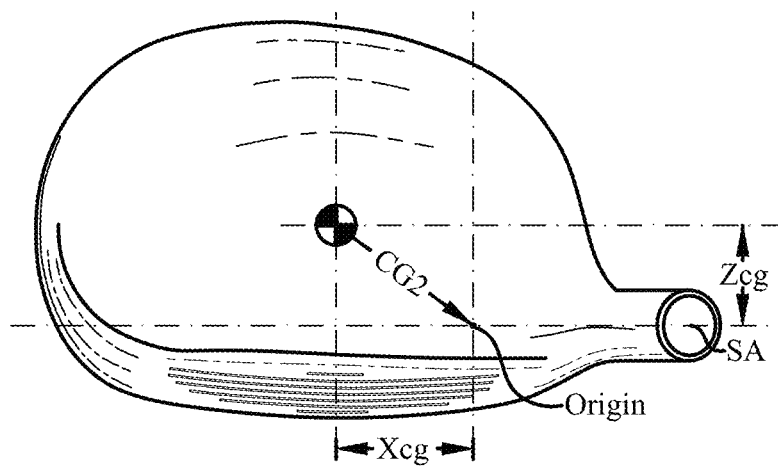

Fig. 16

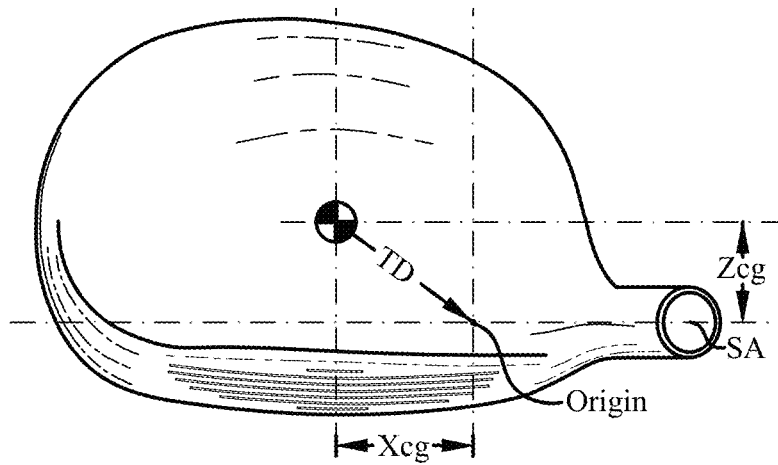

Fig. 17

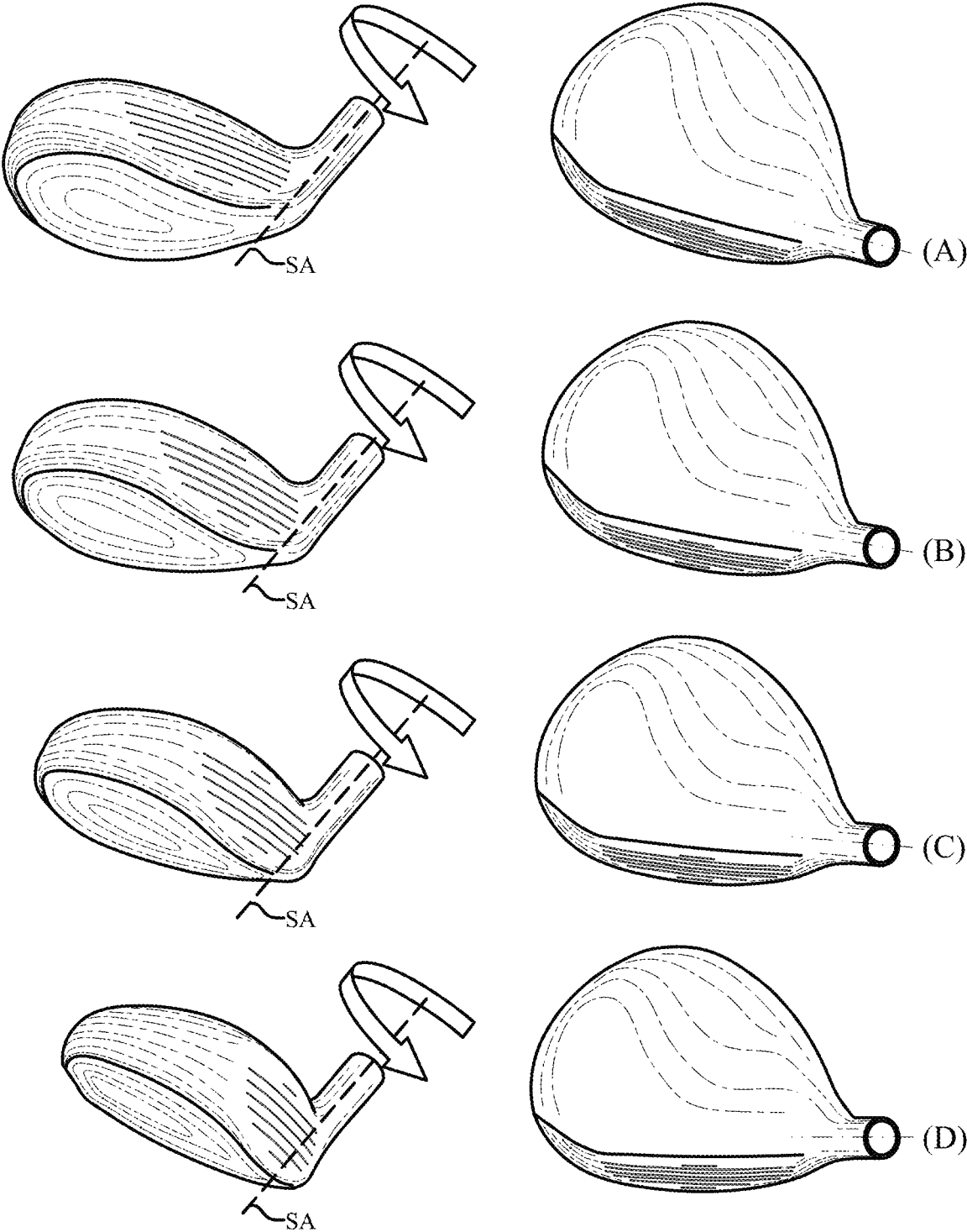

Fig. 18

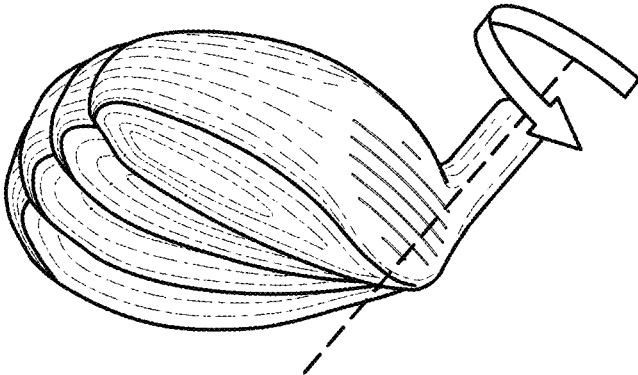

Fig. 19

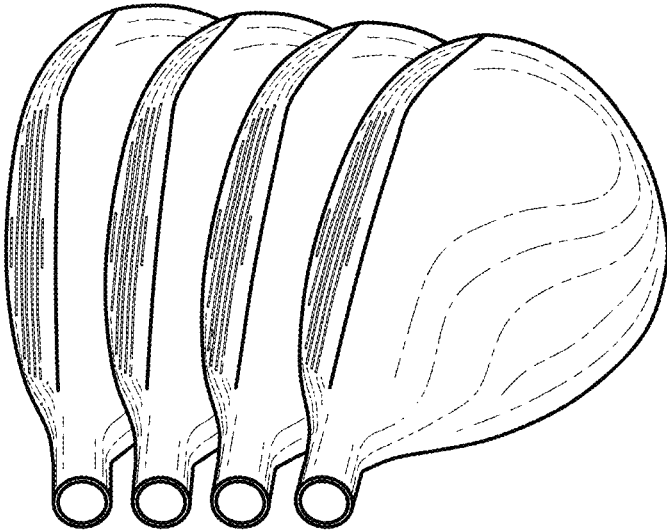

Fig. 20

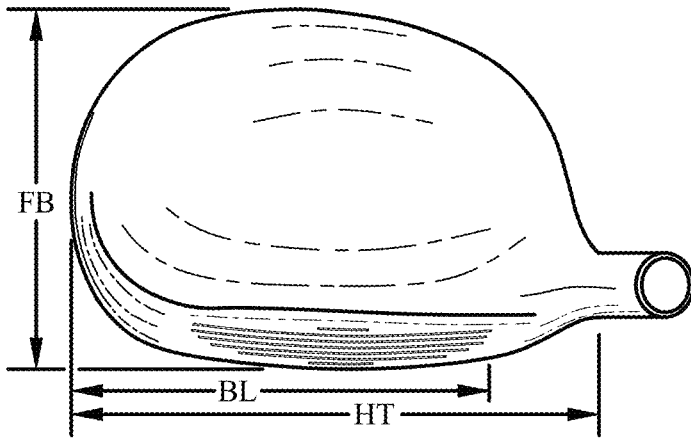

Fig. 21

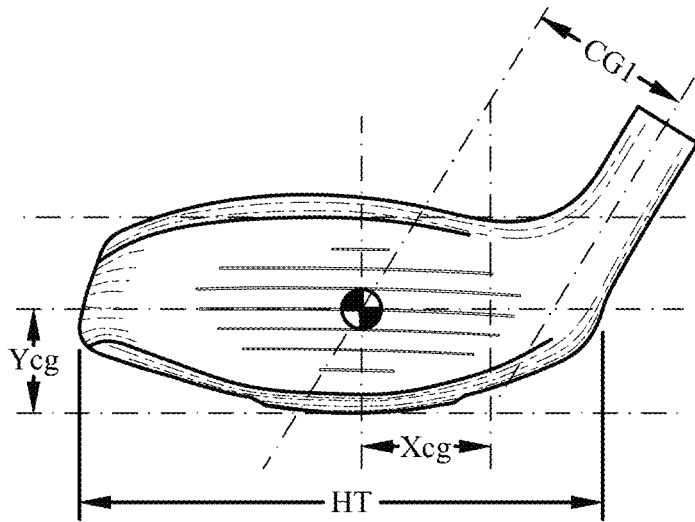

Fig. 22

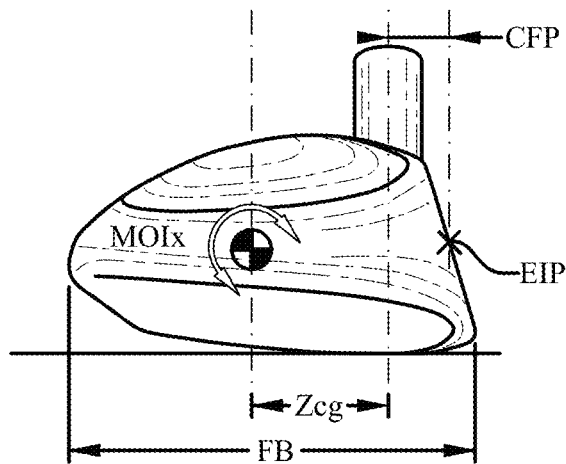

Fig. 23

Conventional F.W.
(Prior Art)

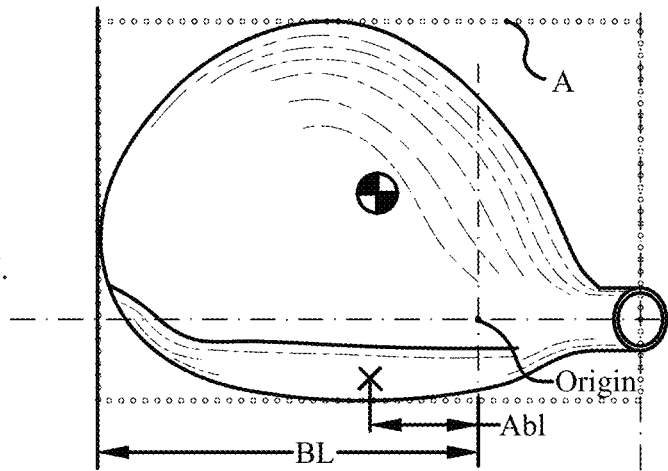

Fig. 24

Oversized F.W.
(Prior Art)

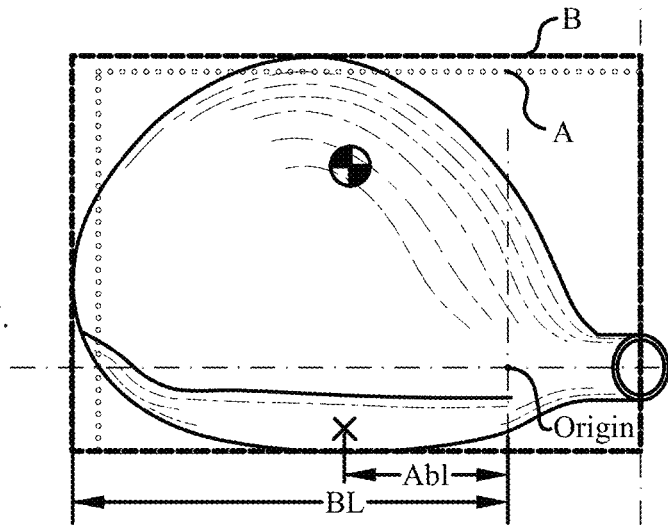

Fig. 25

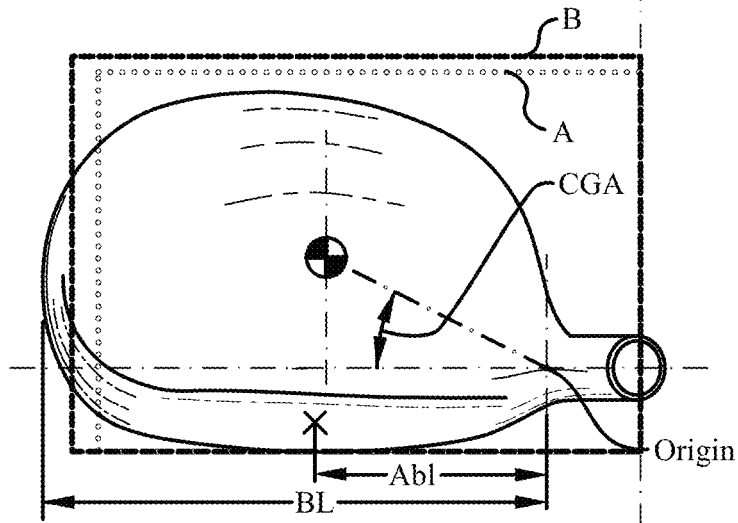

Fig. 26

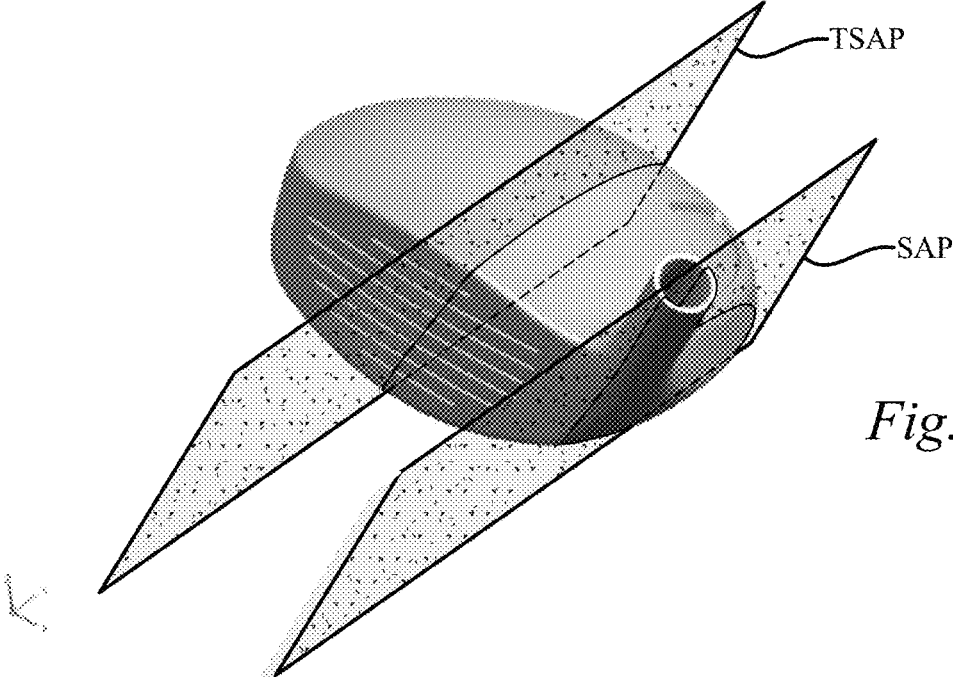

Fig. 27

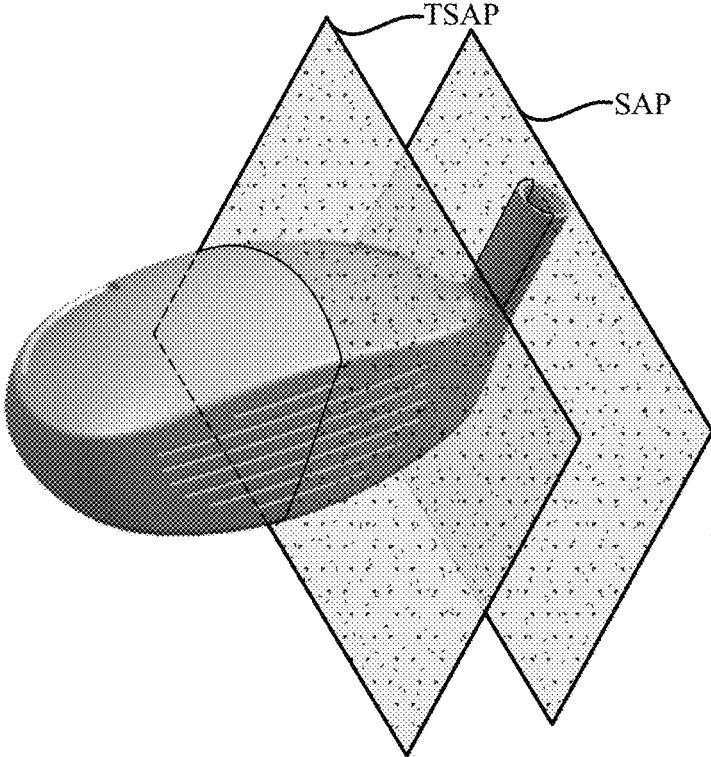

Fig. 28

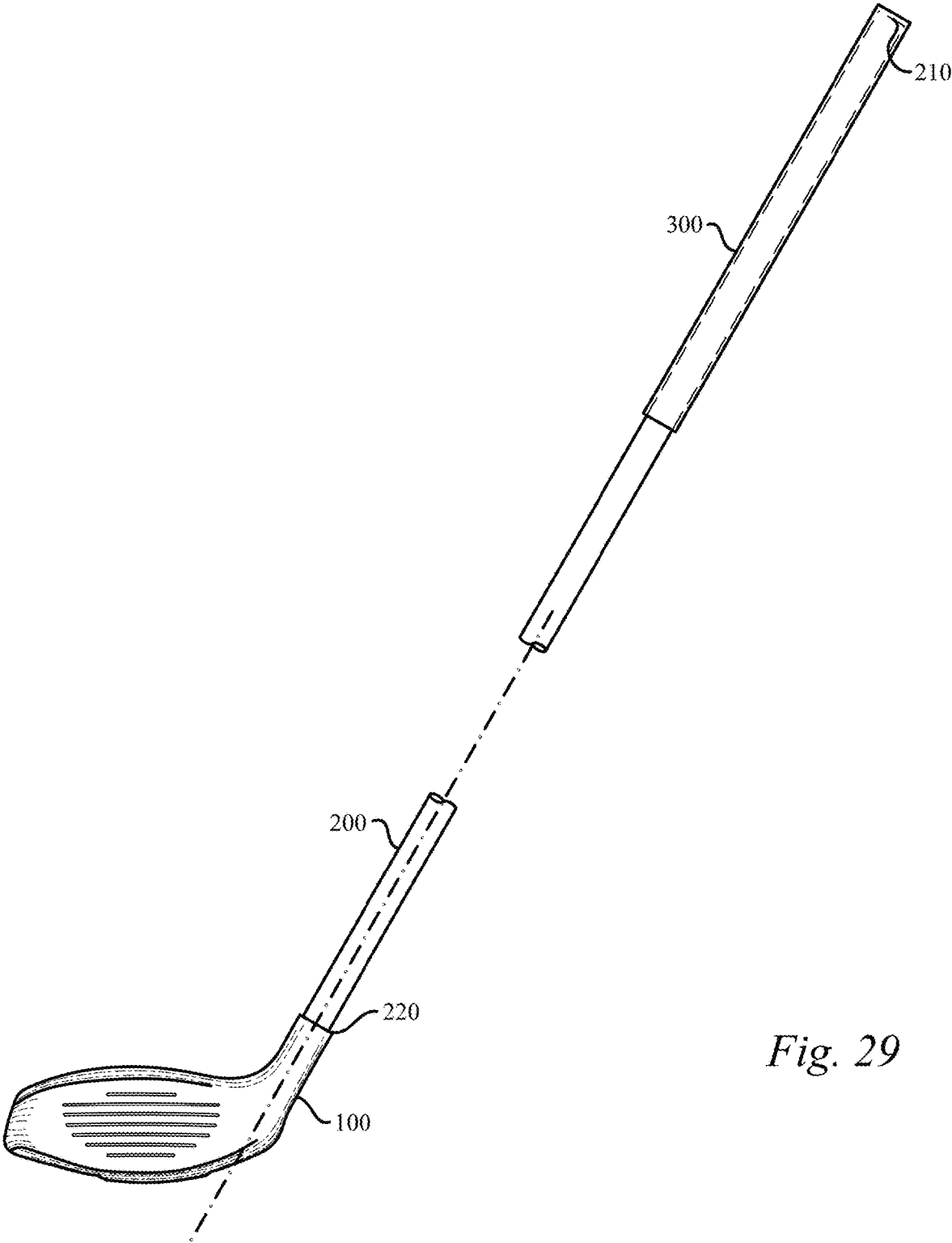

Fig. 29

PRIOR ART MEASURED DATA	Prior Art Product A	Prior Art Product B	Prior Art Product C	Prior Art Product D	Prior Art Product E	Prior Art Product F	Prior Art Product G	Prior Art Product H	Prior Art Product I	Prior Art Product J	Prior Art Product K	Prior Art Product L	Prior Art Product M	Prior Art Product N	Prior Art Product O	Prior Art Product P	Prior Art Product Q	Prior Art Product R	Prior Art Product S	Prior Art Product T	Average
	MOI	2119	2476	2427	1858	2502	2358	2652	2688	2956	3001	2729	2695	2981	2428	2768	2538	2672	3181	2400	2533
Club Moment Arm (CMA)	1.078	1.116	1.024	1.068	1.016	1.129	1.160	1.210	0.827	1.071	1.114	0.941	1.202	0.969	0.926	0.936	0.963	1.293	1.001	1.196	1.062
"Abt" Dimension	0.759	0.921	0.780	0.744	0.911	0.931	0.986	0.871	0.863	1.002	0.893	0.848	0.850	0.900	1.057	1.076	1.071	1.098	0.860	1.017	0.918
Blade Length (BL)	2.800	3.204	2.912	2.822	2.993	2.823	2.874	2.844	2.838	3.110	3.028	3.042	3.192	2.938	2.949	3.181	3.095	3.294	2.898	3.167	3.003

Fig. 30

PRIOR ART MEASURED DATA	Prior Art Product A	Prior Art Product B	Prior Art Product C	Prior Art Product D	Prior Art Product E	Prior Art Product F	Prior Art Product G	Prior Art Product H	Prior Art Product I	Prior Art Product J	Prior Art Product K	Prior Art Product L	Prior Art Product M	Prior Art Product N	Prior Art Product O	Prior Art Product P	Prior Art Product Q	Prior Art Product R	Prior Art Product S	Prior Art Product T	Average
	MOIy	2.118	2.676	2.427	1.868	2.502	2.958	2.662	2.686	2.936	3.001	2.729	2.695	2.991	2.438	2.368	2.628	2.672	3.181	2.400	2.532
Club Moment Arm (CMA)	1.076	1.116	1.024	1.068	1.016	1.129	1.160	1.210	0.827	1.071	1.114	0.941	1.202	0.969	0.936	0.928	0.988	1.293	1.001	1.186	1.062
"Abr" Dimension	0.759	0.921	0.780	0.744	0.911	0.931	0.938	0.871	0.963	1.002	0.893	0.848	0.850	0.900	1.047	1.076	1.071	1.098	0.980	1.017	0.918
Blade Length (BL)	2.800	3.204	2.912	2.822	2.983	2.823	2.874	2.844	2.638	3.110	3.028	3.043	3.192	2.938	2.869	3.181	3.095	3.294	2.898	3.167	3.003
Front to Back Dim (FB)	3.062	3.373	3.062	3.064	2.886	3.162	3.154	3.401	3.314	3.280	3.214	3.288	3.569	3.001	3.030	3.125	3.068	3.477	3.130	3.079	3.167
(FB) / (BL)	1.094	1.063	1.062	1.085	0.966	1.123	1.097	1.186	1.188	1.056	1.061	1.081	1.112	1.021	1.007	0.982	0.991	1.055	1.090	0.972	1.053

Fig. 31

PRIOR ART MEASURED DATA	Prior Art Product A	Prior Art Product B	Prior Art Product C	Prior Art Product D	Prior Art Product E	Prior Art Product F	Prior Art Product G	Prior Art Product H	Prior Art Product I	Prior Art Product J	Prior Art Product K	Prior Art Product L	Prior Art Product M	Prior Art Product N	Prior Art Product O	Prior Art Product P	Prior Art Product Q	Prior Art Product R	Prior Art Product S	Prior Art Product T	Average
	MOI	2118	2876	2427	1888	2502	2388	2652	2886	2698	3001	2729	2896	2961	2428	2288	2528	2672	3181	2400	2532
Club Moment Arm (CMA)	1.076	1.116	1.034	1.068	1.016	1.129	1.160	1.210	0.827	1.071	1.114	0.941	1.202	0.969	0.926	0.928	0.986	1.293	1.001	1.186	1.062
"Abi" Dimension	0.759	0.921	0.760	0.744	0.811	0.931	0.888	0.871	0.863	1.003	0.893	0.848	0.850	0.900	1.057	1.076	1.071	1.098	0.880	1.017	0.918
Blade Length (BL)	2.800	3.204	2.912	2.822	2.993	2.623	2.874	2.844	2.838	3.110	3.028	3.042	3.192	2.938	2.999	3.181	3.095	3.294	2.898	3.167	3.003
Front to Back Dim (FB)	3.062	3.373	3.092	3.064	2.888	3.182	3.154	3.401	3.314	3.290	3.214	3.288	3.550	3.001	3.020	3.125	3.068	3.477	3.130	3.079	3.187
(Abi) / (FB)	0.248	0.273	0.252	0.243	0.316	0.294	0.282	0.256	0.260	0.305	0.278	0.258	0.240	0.300	0.350	0.344	0.349	0.316	0.281	0.330	0.289
Face Closing MOI (MOI _{fc})	3321	4353	3638	2932	4126	3637	3937	4391	4998	4433	4762	4012	4947	3702	3991	4288	4162	5509	3738	4671	4178

Fig. 32

PRIOR ART MEASURED DATA	Prior Art Product A	Prior Art Product B	Prior Art Product C	Prior Art Product D	Prior Art Product E	Prior Art Product F	Prior Art Product G	Prior Art Product H	Prior Art Product I	Prior Art Product J	Prior Art Product K	Prior Art Product L	Prior Art Product M	Prior Art Product N	Prior Art Product O	Prior Art Product P	Prior Art Product Q	Prior Art Product R	Prior Art Product S	Prior Art Product T	Average
	MOIy	2118	2876	2427	1868	2502	2388	2662	2686	2698	3001	2729	2885	2961	2428	2368	2528	2672	3181	2400	2632
Club Moment Arm (CMA)	1.076	1.116	1.024	1.068	1.016	1.128	1.180	1.210	0.927	1.071	1.114	0.941	1.202	0.969	0.926	0.928	0.968	1.283	1.001	1.186	1.062
"Abl" Dimension	0.759	0.921	0.760	0.744	0.911	0.931	0.888	0.871	0.963	1.002	0.893	0.848	0.650	0.900	1.057	1.076	1.071	1.098	0.860	1.017	0.918
Blade Length (BL)	2.800	3.204	2.912	2.922	2.983	2.823	2.974	2.844	2.838	3.110	3.028	3.042	3.192	2.938	2.959	3.181	3.095	3.294	2.888	3.167	3.003
Xcg	0.827	0.897	0.802	0.784	0.984	0.813	0.813	0.851	0.893	0.926	1.045	0.811	0.962	0.875	0.987	1.035	0.933	1.074	0.877	1.114	0.916
Ycg	0.670	0.538	0.534	0.629	0.597	0.677	0.741	0.880	0.605	0.583	0.690	0.774	0.706	0.661	0.612	0.675	0.728	0.600	0.643	0.612	0.563
Zcg	0.452	0.539	0.496	0.435	0.483	0.503	0.514	0.500	0.940	0.439	0.602	0.554	0.726	0.392	0.512	0.468	0.468	0.709	0.476	0.586	0.545
CG angle (CGA)	38.7	31.0	31.7	29.1	26.2	31.7	32.3	35.2	48.5	25.4	29.9	34.3	37.0	34.1	27.4	24.3	36.7	33.4	28.5	27.7	30.8

Fig. 33

PRIOR ART MEASURED DATA	Prior Art Product A	Prior Art Product B	Prior Art Product C	Prior Art Product D	Prior Art Product E	Prior Art Product F	Prior Art Product G	Prior Art Product H	Prior Art Product I	Prior Art Product J	Prior Art Product K	Prior Art Product L	Prior Art Product M	Prior Art Product N	Prior Art Product O	Prior Art Product P	Prior Art Product Q	Prior Art Product R	Prior Art Product S	Prior Art Product T	Average
	MOM	2118	2876	2427	1868	2502	2369	2652	2886	2696	3001	2729	2695	2961	2428	2258	2528	2672	3181	2400	2532
Club Moment Arm (CMA)	1.076	1.116	1.024	1.068	1.016	1.129	1.180	1.210	0.827	1.071	1.114	0.941	1.202	0.969	0.926	0.928	0.988	1.293	1.001	1.186	1.062
"Abl" Dimension	0.759	0.921	0.760	0.744	0.911	0.931	0.868	0.871	0.863	1.002	0.899	0.848	0.850	0.900	1.057	1.076	1.071	1.098	0.880	1.017	0.918
Blade Length (BL)	2.800	3.204	2.912	2.872	2.993	2.823	2.874	2.844	2.838	3.110	3.028	3.042	3.192	2.938	2.989	3.161	3.085	3.294	2.898	3.167	3.003
(CMA)/(Abl)	1.417	1.212	1.312	1.434	1.114	1.214	1.306	1.369	0.958	1.069	1.247	1.110	1.414	1.076	0.876	0.863	0.923	1.177	1.197	1.166	1.157

Fig. 34

PRIOR ART MEASURED DATA	Prior Art Product A	Prior Art Product B	Prior Art Product C	Prior Art Product D	Prior Art Product E	Prior Art Product F	Prior Art Product G	Prior Art Product H	Prior Art Product I	Prior Art Product J	Prior Art Product K	Prior Art Product L	Prior Art Product M	Prior Art Product N	Prior Art Product O	Prior Art Product P	Prior Art Product Q	Prior Art Product R	Prior Art Product S	Prior Art Product T	Average
	MOI	2116	2376	2427	1858	2502	2358	2652	2686	2538	3001	2729	2695	2951	2428	2268	2528	2672	3181	2400	2532
Club Moment Arm (CMA)	1.076	1.116	1.024	1.068	1.016	1.129	1.180	1.210	0.827	1.071	1.114	0.941	1.202	0.969	0.926	0.928	0.988	1.293	1.001	1.185	1.062
"Abt" Dimension	0.759	0.921	0.760	0.744	0.911	0.931	0.868	0.671	0.863	1.002	0.893	0.848	0.850	0.900	1.057	1.076	1.071	1.098	0.880	1.017	0.918
Blade Length (BL)	2.803	3.204	2.912	2.822	2.993	2.823	2.674	2.844	2.638	3.110	3.028	3.042	3.193	2.938	2.999	3.181	3.095	3.294	2.898	3.167	3.003
(Abt)/(BL)	0.271	0.288	0.268	0.264	0.304	0.330	0.309	0.306	0.304	0.322	0.295	0.279	0.266	0.306	0.352	0.338	0.346	0.333	0.304	0.321	0.306

Fig. 35

PRIOR ART MEASURED DATA		Prior Art Product A	Prior Art Product B	Prior Art Product C	Prior Art Product D	Prior Art Product E	Prior Art Product F	Prior Art Product G	Prior Art Product H	Prior Art Product I	Prior Art Product J	Prior Art Product K	Prior Art Product L	Prior Art Product M	Prior Art Product N	Prior Art Product O	Prior Art Product P	Prior Art Product Q	Prior Art Product R	Prior Art Product S	Prior Art Product T	Average
MOI	2118	2878	2427	1866	2502	2366	2666	2886	2886	3001	2729	2695	2951	2428	2268	2528	2672	3181	2400	2532	2589	
Keg	0.837	0.807	0.802	0.784	0.864	0.813	0.813	0.851	0.883	0.926	1.045	0.811	0.962	0.876	0.987	1.035	0.933	1.074	0.877	1.114	0.915	
Ycg	0.670	0.638	0.634	0.629	0.597	0.677	0.741	0.680	0.695	0.683	0.690	0.774	0.706	0.681	0.812	0.678	0.728	0.600	0.642	0.812	0.683	
Zcg	0.452	0.538	0.493	0.435	0.483	0.503	0.514	0.600	0.640	0.439	0.602	0.554	0.726	0.392	0.512	0.468	0.468	0.709	0.478	0.586	0.545	
Club Moment Arm (Center)	1.076	1.116	1.024	1.068	1.016	1.129	1.160	1.210	0.827	1.071	1.114	0.941	1.202	0.959	0.926	0.938	0.988	1.293	1.001	1.186	1.062	
"Abt" Dimension	0.759	0.921	0.780	0.744	0.911	0.931	0.888	0.871	0.863	1.002	0.883	0.848	0.850	0.900	1.057	1.076	1.071	1.098	0.880	1.017	0.918	
Blade Length (BL)	2.800	3.204	2.912	2.622	2.893	3.623	2.874	2.844	2.838	3.110	3.028	3.042	3.192	2.936	2.999	3.181	3.065	3.294	2.899	3.167	3.003	
Transfer Distance (TD)	0.942	1.047	0.942	0.897	1.096	0.956	0.961	1.042	1.287	1.024	1.206	0.982	1.205	0.959	1.112	1.126	1.043	1.287	0.968	1.259	1.070	
Club Head Mass (grams)	269.9	298.9	211.5	205.2	210.6	215.3	215.4	215	212	211.5	216.7	211.6	211.9	214.9	216	211.5	212.2	217.6	208.3	209.2	212.3	
Face Closing MOI (MOI _{fc})	3321	4353	3638	2932	4136	3637	3927	4391	4999	4433	4762	4012	4947	3702	3591	4288	4182	5509	3736	4671	4176	

Fig. 36

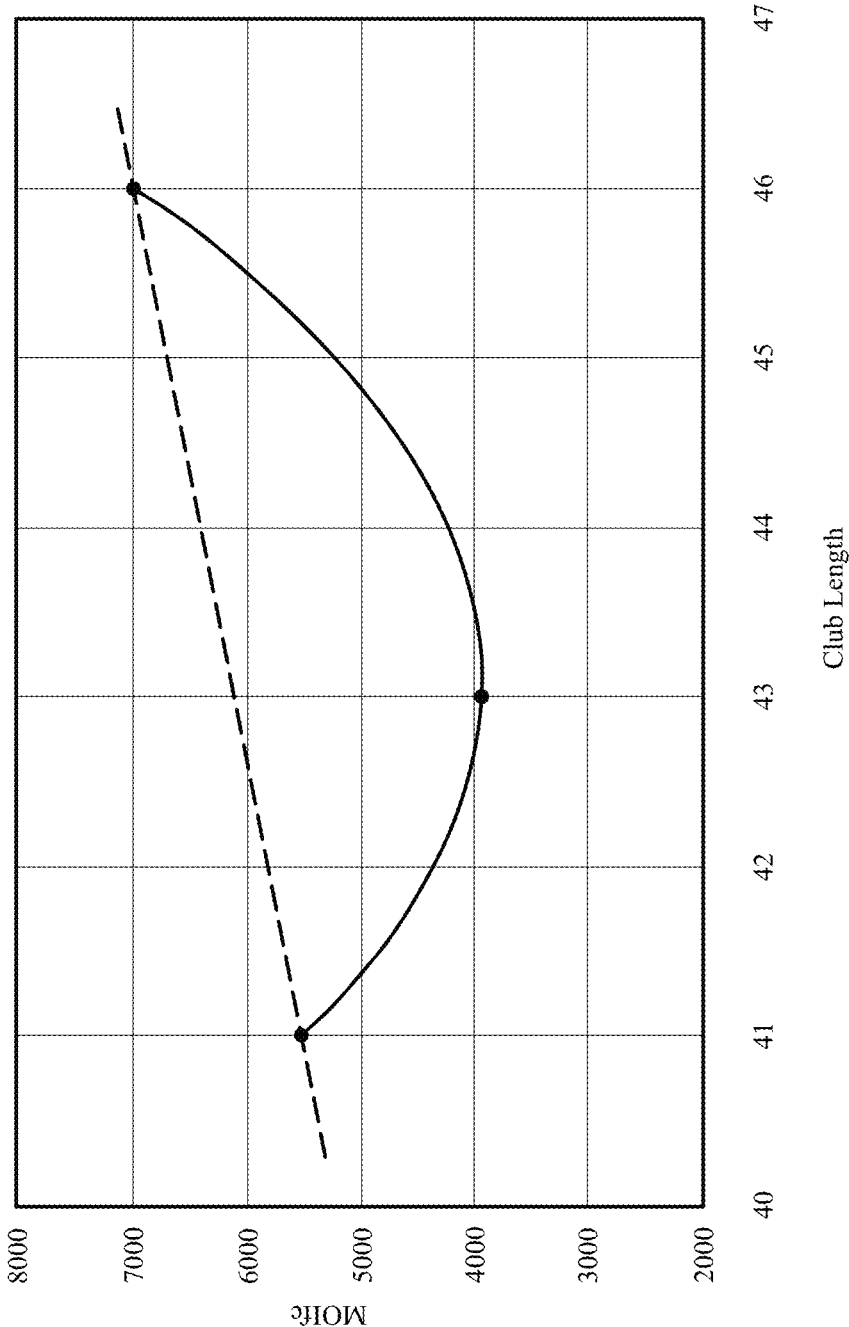

Fig. 37

1

GOLF CLUB**CROSS-REFERENCE TO RELATED APPLICATIONS**

This application is a continuation of U.S. patent application Ser. No. 16/108,299, filed on Aug. 22, 2018, which is a continuation of U.S. patent application Ser. No. 15/632,417, filed on Jun. 26, 2017, which is a continuation of U.S. patent application Ser. No. 14/865,379, filed on Sep. 25, 2015, which is a continuation of U.S. patent application Ser. No. 14/060,948, filed on Oct. 23, 2013, now U.S. Pat. No. 9,168,431, which is a continuation of U.S. patent application Ser. No. 13/716,437, filed on Dec. 17, 2012, now U.S. Pat. No. 8,591,353, which is a continuation of U.S. patent application Ser. No. 13/476,321, filed on May 21, 2012, now U.S. Pat. No. 8,357,058, which is a continuation of U.S. patent application Ser. No. 12/609,209, filed on Oct. 30, 2009, now U.S. Pat. No. 8,206,244, which is a continuation-in-part of U.S. patent application Ser. No. 11/972,368, filed Jan. 10, 2008, now U.S. Pat. No. 7,632,196, the content of which is hereby incorporated by reference as if completely written herein.

STATEMENT REGARDING FEDERALLY SPONSORED RESEARCH OR DEVELOPMENT

This invention was not made as part of a federally sponsored research or development project.

TECHNICAL FIELD

The present invention relates to the field of golf clubs, namely fairway wood type golf clubs. The present invention is a fairway wood type golf club characterized by a long blade length with a long heel blade length section, while having a small club moment arm and very low center of gravity.

BACKGROUND OF THE INVENTION

Fairway wood type golf clubs are unique in that they are essential to a golfer's course management, yet fairway woods have been left behind from a technological perspective compared to many of the other golf clubs in a golfer's bag. For instance, driver golf clubs have made tremendous technological advances in recent years; as have iron golf clubs, especially with the incorporation of more hybrid long irons into golf club sets.

Majority of the recent advances in these golf clubs have focused on positioning the center of gravity of the golf club head as low as possible and as far toward the rear of the golf club head as possible, along with attempting to increase the moment of inertia of the golf club head to reduce club head twisting at impact due to shots hit toward the toe or heel of the club head. Several unintended consequences came along with the benefits associated with these advances. The present invention is directed at addressing several of the unintended consequences in the field of fairway wood type golf clubs.

SUMMARY OF INVENTION

In its most general configuration, the present invention advances the state of the art with a variety of new capabilities and overcomes many of the shortcomings of prior methods in new and novel ways. In its most general sense,

2

the present invention overcomes the shortcomings and limitations of the prior art in any of a number of generally effective configurations.

The present invention is a unique fairway wood type golf club. The club is a fairway wood type golf club characterized by a long blade length with a long heel blade length section, while having a small club moment arm and unique weight distribution, and all the benefits afforded therefrom. The fairway wood incorporates the discovery of unique relationships among key club head engineering variables that are inconsistent with merely striving to obtain a high MOI using conventional golf club head design wisdom. The resulting fairway wood has a face closing moment of inertia (MOI_{fc}) more closely matched with modern drivers and long hybrid iron golf clubs, allowing golfers to have a similar feel whether swinging a modern driver, the present fairway wood, or a modern hybrid golf club.

Numerous variations, modifications, alternatives, and alterations of the various preferred embodiments, processes, and methods may be used alone or in combination with one another as will become more readily apparent to those with skill in the art with reference to the following detailed description of the preferred embodiments and the accompanying figures and drawings.

BRIEF DESCRIPTION OF THE DRAWINGS

Without limiting the scope of the present invention as claimed below and referring now to the drawings and figures:

FIG. 1 shows a front elevation view of an embodiment of the present invention, not to scale;

FIG. 2 shows a top plan view of an embodiment of the present invention, not to scale;

FIG. 3 shows a front elevation view of an embodiment of the present invention, not to scale;

FIG. 4 shows a toe side elevation view of an embodiment of the present invention, not to scale;

FIG. 5 shows a top plan view of an embodiment of the present invention, not to scale;

FIG. 6 shows a toe side elevation view of an embodiment of the present invention, not to scale;

FIG. 7 shows a front elevation view of an embodiment of the present invention, not to scale;

FIG. 8 shows a toe side elevation view of an embodiment of the present invention, not to scale;

FIG. 9 shows a front elevation view of an embodiment of the present invention, not to scale;

FIG. 10 shows a front elevation view of an embodiment of the present invention, not to scale;

FIG. 11 shows a front elevation view of an embodiment of the present invention, not to scale;

FIG. 12 shows a front elevation view of an embodiment of the present invention, not to scale;

FIG. 13 shows a front elevation view of an embodiment of the present invention, not to scale;

FIG. 14 shows a top plan view of an embodiment of the present invention, not to scale;

FIG. 15 shows a front elevation view of an embodiment of the present invention, not to scale;

FIG. 16 shows a top plan view of an embodiment of the present invention, not to scale;

FIG. 17 shows a top plan view of an embodiment of the present invention, not to scale;

FIG. 18 shows a step-wise progression of an embodiment of the present invention as the golf club head approaches the impact with a golf ball during a golf swing, not to scale;

FIG. 19 shows a step-wise progression of an embodiment of the present invention as the golf club head approaches the impact with a golf ball during a golf swing, not to scale;

FIG. 20 shows a step-wise progression of an embodiment of the present invention as the golf club head approaches the impact with a golf ball during a golf swing, not to scale;

FIG. 21 shows a top plan view of an embodiment of the present invention, not to scale;

FIG. 22 shows a front elevation view of an embodiment of the present invention, not to scale;

FIG. 23 shows a toe side elevation view of an embodiment of the present invention, not to scale;

FIG. 24 shows a top plan view of a prior art conventional fairway wood, not to scale;

FIG. 25 shows a top plan view of a prior art oversized fairway wood, not to scale;

FIG. 26 shows a top plan view of an embodiment of the present invention, not to scale;

FIG. 27 shows a perspective view of an embodiment of the present invention, not to scale;

FIG. 28 shows a perspective view of an embodiment of the present invention, not to scale;

FIG. 29 shows a front elevation view of an embodiment of the present invention, not to scale;

FIG. 30 shows a table of data for currently available prior art fairway wood type golf club heads;

FIG. 31 shows a table of data for currently available prior art fairway wood type golf club heads;

FIG. 32 shows a table of data for currently available prior art fairway wood type golf club heads;

FIG. 33 shows a table of data for currently available prior art fairway wood type golf club heads;

FIG. 34 shows a table of data for currently available prior art fairway wood type golf club heads;

FIG. 35 shows a table of data for currently available prior art fairway wood type golf club heads;

FIG. 36 shows a table of data for currently available prior art fairway wood type golf club heads; and

FIG. 37 is a graph of the face closing moment (MOI_{fc}) versus club length.

DETAILED DESCRIPTION OF THE INVENTION

The fairway wood type golf club of the present invention enables a significant advance in the state of the art. The preferred embodiments of the invention accomplish this by new and novel methods that are configured in unique and novel ways and which demonstrate previously unavailable, but preferred and desirable capabilities. The description set forth below in connection with the drawings is intended merely as a description of the presently preferred embodiments of the invention, and is not intended to represent the only form in which the present invention may be constructed or utilized. The description sets forth the designs, functions, means, and methods of implementing the invention in connection with the illustrated embodiments. It is to be understood, however, that the same or equivalent functions and features may be accomplished by different embodiments that are also intended to be encompassed within the spirit and scope of the invention.

In order to fully appreciate the present invention some common terms must be defined for use herein. First, one of skill in the art will know the meaning of "center of gravity," referred to herein as CG, from an entry level course on the mechanics of solids. With respect to wood-type golf clubs, which are generally hollow and/or having non-uniform

density, the CG is often thought of as the intersection of all the balance points of the club head. In other words, if you balance the head on the face and then on the sole, the intersection of the two imaginary lines passing straight through the balance points would define the point referred to as the CG.

It is helpful to establish a coordinate system to identify and discuss the location of the CG. In order to establish this coordinate system one must first identify a ground plane (GP) and a shaft axis (SA). First, the ground plane (GP) is the horizontal plane upon which a golf club head rests, as seen best in a front elevation view of a golf club head looking at the face of the golf club head, as seen in FIG. 1. Secondly, the shaft axis (SA) is the axis of a bore in the golf club head that is designed to receive a shaft. Some golf club heads have an external hosel that contains a bore for receiving the shaft such that one skilled in the art can easily appreciate the shaft axis (SA), while other "hosel-less" golf clubs have an internal bore that receives the shaft that nonetheless defines the shaft axis (SA). The shaft axis (SA) is fixed by the design of the golf club head and is also illustrated in FIG. 1.

Now, the intersection of the shaft axis (SA) with the ground plane (GP) fixes an origin point, labeled "origin" in FIG. 1, for the coordinate system. While it is common knowledge in the industry, it is worth noting that the right side of the club head seen in FIG. 1 is the side nearest the bore in which the shaft attaches is the "heel" side of the golf club head; and the opposite side, the left side in FIG. 1, is referred to as the "toe" side of the golf club head. Additionally, the portion of the golf club head that actually strikes a golf ball is referred to as the face of the golf club head and is commonly referred to as the front of the golf club head; whereas the opposite end of the golf club head is referred to as the rear of the golf club head and/or the trailing edge.

A three dimensional coordinate system may now be established from the origin with the Y-direction being the vertical direction from the origin; the X-direction being the horizontal direction perpendicular to the Y-direction and wherein the X-direction is parallel to the face of the golf club head in the natural resting position, also known as the design position; and the Z-direction is perpendicular to the X-direction wherein the Z-direction is the direction toward the rear of the golf club head. The X, Y, and Z directions are noted on a coordinate system symbol in FIG. 1. It should be noted that this coordinate system is contrary to the traditional right-hand rule coordinate system; however it is preferred so that the center of gravity may be referred to as having all positive coordinates.

Now, with the origin and coordinate system defined, the terms that define the location of the CG may be explained. One skilled in the art will appreciate that the CG of a hollow golf club head such as the wood-type golf club head illustrated in FIG. 2 will be behind the face of the golf club head. The distance behind the origin that the CG is located is referred to as Z_{cg}, as seen in FIG. 2. Similarly, the distance above the origin that the CG is located is referred to as Y_{cg}, as seen in FIG. 3. Lastly, the horizontal distance from the origin that the CG is located is referred to as X_{cg}, also seen in FIG. 3. Therefore, the location of the CG may be easily identified by reference to X_{cg}, Y_{cg}, and Z_{cg}.

The moment of inertia of the golf club head is a key ingredient in the playability of the club. Again, one skilled in the art will understand what is meant by moment of inertia with respect to golf club heads; however it is helpful to define two moment of inertia components that will be commonly referred to herein. First, MOI_x is the moment of

inertia of the golf club head around an axis through the CG, parallel to the X-axis, labeled in FIG. 4. $MOIx$ is the moment of inertia of the golf club head that resists lofting and delofting moments induced by ball strikes high or low on the face. Secondly, $MOIy$ is the moment of the inertia of the golf club head around an axis through the CG, parallel to the Y-axis, labeled in FIG. 5. $MOIz$ is the moment of inertia of the golf club head that resists opening and closing moments induced by ball strikes towards the toe side or heel side of the face.

Continuing with the definitions of key golf club head dimensions, the "front-to-back" dimension, referred to as the FB dimension, is the distance from the furthest forward point at the leading edge of the golf club head to the furthest rearward point at the rear of the golf club head, i.e. the trailing edge, as seen in FIG. 6. The "heel-to-toe" dimension, referred to as the HT dimension, is the distance from the point on the surface of the club head on the toe side that is furthest from the origin in the X-direction, to the point on the surface of the golf club head on the heel side that is 0.875" above the ground plane and furthest from the origin in the negative X-direction, as seen in FIG. 7.

A key location on the golf club face is an engineered impact point (EIP). The engineered impact point (EIP) is important in that it helps define several other key attributes of the present invention. The engineered impact point (EIP) is generally thought of as the point on the face that is the ideal point at which to strike the golf ball. Generally, the score lines on golf club heads enable one to easily identify the engineered impact point (EIP) for a golf club. In the embodiment of FIG. 9, the first step in identifying the engineered impact point (EIP) is to identify the top score line (TSL) and the bottom score line (BSL). Next, draw an imaginary line (IL) from the midpoint of the top score line (TSL) to the midpoint of the bottom score line (BSL). This imaginary line (IL) will often not be vertical since many score line designs are angled upward toward the toe when the club is in the natural position. Next, as seen in FIG. 10, the club must be rotated so that the top score line (TSL) and the bottom score line (BSL) are parallel with the ground plane (GP), which also means that the imaginary line (IL) will now be vertical. In this position, the leading edge height (LEH) and the top edge height (TEH) are measured from the ground plane (GP). Next, the face height is determined by subtracting the leading edge height (LEH) from the top edge height (TEH). The face height is then divided in half and added to the leading edge height (LEH) to yield the height of the engineered impact point (EIP). Continuing with the club head in the position of FIG. 10, a spot is marked on the imaginary line (IL) at the height above the ground plane (GP) that was just calculated. This spot is the engineered impact point (EIP).

The engineered impact point (EIP) may also be easily determined for club heads having alternative score line configurations. For instance, the golf club head of FIG. 11 does not have a centered top score line. In such a situation, the two outermost score lines that have lengths within 5% of one another are then used as the top score line (TSL) and the bottom score line (BSL). The process for determining the location of the engineered impact point (EIP) on the face is then determined as outlined above. Further, some golf club heads have non-continuous score lines, such as that seen at the top of the club head face in FIG. 12. In this case, a line is extended across the break between the two top score line sections to create a continuous top score line (TSL). The newly created continuous top score line (TSL) is then bisected and used to locate the imaginary line (IL). Again,

then the process for determining the location of the engineered impact point (EIP) on the face is then determined as outlined above.

The engineered impact point (EIP) may also be easily determined in the rare case of a golf club head having an asymmetric score line pattern, or no score lines at all. In such embodiments the engineered impact point (EIP) shall be determined in accordance with the USGA "Procedure for Measuring the Flexibility of a Golf Clubhead," Revision 2.0, Mar. 25, 2005, which is incorporated herein by reference. This USGA procedure identifies a process for determining the impact location on the face of a golf club that is to be tested, also referred therein as the face center. The USGA procedure utilizes a template that is placed on the face of the golf club to determine the face center. In these limited cases of asymmetric score line patterns, or no score lines at all, this USGA face center shall be the engineered impact point (EIP) that is referenced throughout this application.

The engineered impact point (EIP) on the face is an important reference to define other attributes of the present invention. The engineered impact point (EIP) is generally shown on the face with rotated crosshairs labeled EIP.

One important dimension that utilizes the engineered impact point (EIP) is the center face progression (CFP), seen in FIGS. 8 and 14. The center face progression (CFP) is a single dimension measurement and is defined as the distance in the Z-direction from the shaft axis (SA) to the engineered impact point (EIP). A second dimension that utilizes the engineered impact point (EIP) is referred to as a club moment arm (CMA). The CMA is the two dimensional distance from the CG of the club head to the engineered impact point (EIP) on the face, as seen in FIG. 8. Thus, with reference to the coordinate system shown in FIG. 1, the club moment arm (CMA) includes a component in the Z-direction and a component in the Y-direction, but ignores the any difference in the X-direction between the CG and the engineered impact point (EIP). Thus, the club moment arm (CMA) can be thought of in terms of an impact vertical plane passing through the engineered impact point (EIP) and extending in the Z-direction. First, one would translate the CG horizontally in the X-direction until it hits the impact vertical plane. Then, the club moment arm (CMA) would be the distance from the projection of the CG on the impact vertical plane to the engineered impact point (EIP). The club moment arm (CMA) has a significant impact on the launch angle and the spin of the golf ball upon impact.

Another important dimension in golf club design is the club head blade length (BL), seen in FIG. 13 and FIG. 14. The blade length (BL) is the distance from the origin to a point on the surface of the club head on the toe side that is furthest from the origin in the X-direction. The blade length (BL) is composed of two sections, namely the heel blade length section (Abl) and the toe blade length section (Bbl). The point of delineation between these two sections is the engineered impact point (EIP), or more appropriately, a vertical line, referred to as a face centerline (FC), extending through the engineered impact point (EIP), as seen in FIG. 13, when the golf club head is in the normal resting position, also referred to as the design position.

Further, several additional dimensions are helpful in understanding the location of the CG with respect to other points that are essential in golf club engineering. First, a CG angle (CGA) is the one dimensional angle between a line connecting the CG to the origin and an extension of the shaft axis (SA), as seen in FIGS. 14 and 26. The CG angle (CGA) is measured solely in the X-Z plane and therefore does not account for the elevation change between the CG and the

origin, which is why it is easiest understood in reference to the top plan views of FIGS. 14 and 26.

A dimension referred to as CG1, seen in FIG. 15, is most easily understood by identifying two planes through the golf club head, as seen in FIGS. 27 and 28. First, a shaft axis plane (SAP) is a plane through the shaft axis that extends from the face to the rear portion of the golf club head in the Z-direction. Next, a second plane, referred to as the translated shaft axis plane (TSAP), is a plane parallel to the shaft axis plane (SAP) but passing through the GC. Thus, in FIGS. 27 and 28, the translated shaft axis plane (TSAP) may be thought of as a copy of the shaft axis plane (SAP) that has been slid toward the toe until it hits the CG. Now, the CG1 dimension is the shortest distance from the CG to the shaft axis plane (SAP). A second dimension referred to as CG2, seen in FIG. 16 is the shortest distance from the CG to the origin point, thus taking into account elevation changes in the Y-direction.

Lastly, another important dimension in quantifying the present invention only takes into consideration two dimensions and is referred to as the transfer distance (TD), seen in FIG. 17. The transfer distance (TD) is the horizontal distance from the CG to a vertical line extending from the origin; thus, the transfer distance (TD) ignores the height of the CG, or Ycg. Thus, using the Pythagorean Theorem from simple geometry, the transfer distance (TD) is the hypotenuse of a right triangle with a first leg being Xcg and the second leg being Zcg.

The transfer distance (TD) is significant in that it helps define another moment of inertia value that is significant to the present invention. This new moment of inertia value is defined as the face closing moment of inertia, referred to as MOIfc, which is the horizontally translated (no change in Y-direction elevation) version of MOIy around a vertical axis that passes through the origin. MOIfc is calculated by adding MOIy to the product of the club head mass and the transfer distance (TD) squared. Thus,

$$\text{MOIfc} = \text{MOIy} + (\text{mass} * \text{TD})^2$$

The face closing moment (MOIfc) is important because it represents the resistance that a golfer feels during a swing when trying to bring the club face back to a square position for impact with the golf ball. In other words, as the golf swing returns the golf club head to its original position to impact the golf ball the face begins closing with the goal of being square at impact with the golf ball. For instance, the figures of FIGS. 18(A), (B), (C), and (D) illustrate the face of the golf club head closing during the downswing in preparation for impact with the golf ball. This stepwise closing of the face is also illustrated in FIGS. 19 and 20. The significance of the face closing moment (MOIfc) will be explained later herein.

The fairway wood type golf club of the present invention has a shape and mass distribution unlike prior fairway wood type golf clubs. The fairway wood type golf club of the present invention includes a shaft (200) having a proximal end (210) and a distal end (220); a grip (300) attached to the shaft proximal end (210); and a golf club head (100) attached at the shaft distal end (220), as seen in FIG. 29. The overall fairway wood type golf club has a club length of at least 41 inches and no more than 45 inches, as measured in accordance with USGA guidelines.

The golf club head (100) itself is a hollow structure that includes a face positioned at a front portion of the golf club head where the golf club head impacts a golf ball, a sole positioned at a bottom portion of the golf club head, a crown positioned at a top portion of the golf club head, and a skirt

positioned around a portion of a periphery of the golf club head between the sole and the crown. The face, sole, crown, and skirt define an outer shell that further defines a head volume that is less than 250 cubic centimeters for the present invention. Additionally, the golf club head has a rear portion opposite the face. The rear portion includes the trailing edge of the golf club, as is understood by one with skill in the art. The face has a loft of at least 12 degrees and no more than 27 degrees, and the face includes an engineered impact point (EIP) as defined above. One skilled in the art will appreciate that the skirt may be significant at some areas of the golf club head and virtually nonexistent at other areas; particularly at the rear portion of the golf club head where it is not uncommon for it to appear that the crown simply wraps around and becomes the sole.

The golf club head (100) includes a bore having a center that defines a shaft axis (SA) which intersects with a horizontal ground plane (GP) to define an origin point, as previously explained. The bore is located at a heel side of the golf club head and receives the shaft distal end for attachment to the golf club head. The golf club head (100) also has a toe side located opposite of the heel side. The golf club head (100) of the present invention has a club head mass of less than 230 grams, which combined with the previously disclosed loft, club head volume, and club length establish that the present invention is directed to a fairway wood golf club.

As previously explained, the golf club head (100) has a blade length (BL) that is measured horizontally from the origin point toward the toe side of the golf club head a distance that is parallel to the face and the ground plane (GP) to the most distant point on the golf club head in this direction. The golf club head (100) of the present invention has a blade length (BL) of at least 3.1 inches. Further, the blade length (BL) includes a heel blade length section (Abl) and a toe blade length section (Bbl). The heel blade length section (Abl) is measured in the same direction as the blade length (BL) from the origin point to the vertical line extending through the engineered impact point (EIP), and in the present invention the heel blade length section (Abl) is at least 1.1 inches. As will be subsequently explained, the blade length (BL) and the heel blade length section (Abl) of the present invention are unique to the field of fairway woods, particularly when combined with the disclosure below regarding the relatively small club moment arm (CMA), high MOIy, in some embodiments, and very low center of gravity, in some embodiments, which fly in the face of conventional golf club design engineering.

The golf club head (100) of the present invention has a center of gravity (CG) located (a) vertically toward the top portion of the golf club head from the origin point a distance Ycg; (b) horizontally from the origin point toward the toe side of the golf club head a distance Xcg that is generally parallel to the face and the ground plane (GP); and (c) a distance Zcg from the origin toward the rear portion in a direction orthogonal to the vertical direction used to measure Ycg and orthogonal to the horizontal direction used to measure Xcg.

The present golf club head (100) has a club moment arm (CMA) from the CG to the engineered impact point (EIP) of less than 1.1 inches. The definition of the club moment arm (CMA) and engineered impact point (EIP) have been disclosed in great detail above and therefore will not be repeated here. This is particularly significant when contrasted with the fact that one embodiment of the present invention has a first moment of inertia (MOIy) about a vertical axis through the CG of at least 3000 g*cm², which

is high in the field of fairway wood golf clubs, as well as the blade length (BL) and heel blade length section (Abl) characteristics previously explained.

The advances of the present invention are significant because prior thinking in the field of fairway woods has generally led to one of two results, both of which lack the desired high MOI_y, or the desired low CG, depending on the embodiment, combined with the other properties of the claimed invention.

The first common trend has been to produce oversized fairway woods, such as prior art product R in the table of FIG. 30, in which an oversized head was used to obtain a relatively high MOI_y at the expense of a particular large club moment arm (CMA) value of almost 1.3 inches, which is over 17.5 percent greater than the maximum club moment arm (CMA) of the present invention. Further, this prior art large club moment arm (CMA) club does not obtain the specified desired heel blade length section (Abl) dimension of the present invention. This is particularly illustrative of common thinking in club head engineering that to produce a high MOI_y game improvement type product that the club head must get large in all directions, which results in a CG located far from the face of the club and thus a large club moment arm (CMA). A generic oversized fairway wood is seen in FIG. 25. The club moment arm (CMA) has a significant impact on the ball flight of off-center hits. Importantly, a shorter club moment arm (CMA) produces less variation between shots hit at the engineered impact point (EIP) and off-center hits. Thus, a golf ball struck near the heel or toe of the present invention will have launch conditions more similar to a perfectly struck shot. Conversely, a golf ball struck near the heel or toe of an oversized fairway wood with a large club moment arm (CMA) would have significantly different launch conditions than a ball struck at the engineered impact point (EIP) of the same oversized fairway wood.

Generally, larger club moment arm (CMA) golf clubs impart higher spin rates on the golf ball when perfectly struck in the engineered impact point (EIP) and produce larger spin rate variations in off-center hits. The present invention's reduction of club moment arm (CMA) while still obtaining a high MOI_y and/or low CG position, and the desired minimum heel blade length section (Abl) is opposite of what prior art designs have attempted to achieve with oversized fairway woods, and has resulted in a fairway wood with more efficient launch conditions including a lower ball spin rate per degree of launch angle, thus producing a longer ball flight.

The second common trend in fairway wood design has been to stick with smaller club heads for more skilled golfers, as seen in FIG. 24. One basis for this has been to reduce the amount of ground contact. Unfortunately, the smaller club head results in a reduced hitting area making these clubs difficult for the average golfer to hit. A good example of one such club is prior art product I in the table of FIG. 30. Prior art product I has achieved a small club moment arm (CMA), but has done so at the expense of small blade length (BL) of 2.838 inches, a small heel blade length section (Abl) dimension of 0.863 inches. Thus, the present invention's increase in blade length (BL) and the minimum heel blade length section (Abl), while being able to produce a high MOI_y, or very low CG elevation, with a small club moment arm (CMA), is unique.

Both of these trends have ignored the changes found in the rest of the golf clubs in a golfer's bag. As will be discussed

in detail further below, advances in driver technology and hybrid iron technology have left fairway woods feeling unnatural and undesirable.

In addition to everything else, the prior art has failed to identify the value in having a fairway wood's engineered impact point (EIP) located a significant distance from the origin point. Conventional wisdom regarding increasing the Zcg value to obtain club head performance has proved to not recognize that it is the club moment arm (CMA) that plays a much more significant role in fairway wood performance and ball flight. Controlling the club moments arm (CMA) in the manner claimed herein, along with the long blade length (BL), long heel blade length section (Abl), while achieving a high MOI_y, or low CG position, for fairway woods, yields launch conditions that vary significantly less between perfect impacts and off-center impacts than has been seen in the past. The present invention provides the penetrating ball flight that is desired with fairway woods via reducing the ball spin rate per degree of launch angle. The presently claimed invention has resulted in reductions in ball spin rate as much as 5 percent or more, while maintaining the desired launch angle. In fact, testing has shown that each hundredth of an inch reduction in club moment arm (CMA) results in a reduction in ball spin rate of up to 13.5 rpm.

In another embodiment of the present invention the ratio of the golf club head front-to-back dimension (FB) to the blade length (BL) is less than 0.925, as seen in FIG. 21. The table FIG. 31 is the table of FIG. 30 with two additional rows added to the bottom illustrating typical prior art front-to-back dimensions (FB) and the associated ratios of front-to-back dimensions (FB) to blade lengths (BL). In this embodiment, the limiting of the front-to-back dimension (FB) of the club head (100) in relation to the blade length (BL) improves the playability of the club, yet still achieves the desired high MOI_y, or low CG location, and small club moment arm (CMA). The reduced front-to-back dimension (FB), and associated reduced Zcg, of the present invention also significantly reduces dynamic lofting of the golf club head. In FIG. 31 only prior art products P, Q, and T even obtain ratios below 1, nowhere near 0.925, and further do not obtain the other characteristics previously discussed. Increasing the blade length (BL) of a fairway wood, while decreasing the front-to-back dimension (FB) and incorporating the previously discussed characteristics with respect to minimum MOI_y, minimum heel blade length section (Abl), and maximum club moment arm (CMA), simply goes against conventional fairway wood golf club head design and produces a golf club head that has improved playability that would not be expected by one practicing conventional fairway wood design principles. Reference to FIGS. 24, 25, and 26 illustrates nicely the unique geometric differences between the present embodiment and prior art fairway woods. In a further embodiment, such as that of FIG. 26, the face, sole, crown, and skirt define an outer shell that further defines a head volume that is less than 170 cubic centimeters.

In yet a further embodiment a unique ratio of the heel blade length section (Abl) to the golf club head front-to-back dimension (FB) has been identified and is at least 0.32. The table shown in FIG. 32 replaces the last row of the table of FIG. 31 with this new ratio of heel blade length section (Abl) to the golf club head front-to-back dimension (FB), as well as adding a row illustrating the face closing moment (MOI_{fc}). Prior art products O, P, Q, and T obtain ratios above 0.32, but are all low MOI_y and low face closing moment (MOI_{fc}) clubs that also fail to achieve the present invention's heel blade length section (Abl) value.

Still another embodiment of the present invention defines the long blade length (BL), long heel blade length section (Abl), and short club moment arm (CMA) relationship through the use of a CG angle (CGA) of no more than 30 degrees. The CG angle (CGA) was previously defined in detail above. Fairway woods with long heel blade length sections (Abl) simply have not had CG angles (CGA) of 30 degrees or less. Generally longer blade length (BL) fairway woods have CG locations that are further back in the golf club head and therefore have large CG angles (CGA), common for oversized fairway woods. For instance, the longest blade length (BL) fairway wood seen in FIG. 33 has a blade length (BL) of 3.294 inches and correspondingly has a CG angle (CGA) of over 33 degrees. A small CG angle (CGA) affords the benefits of a golf club head with a small club moment arm (CMA) and a CG that is far from the origin in the X-direction. An even further preferred embodiment of the present invention has a CG angle (CGA) of 25 degrees or less, further espousing the performance benefits discussed herein.

Yet another embodiment of the present invention expresses the unique characteristics of the present fairway wood in terms of a ratio of the club moment arm (CMA) to the heel blade length section (Abl). In this embodiment the ratio of club moment arm (CMA) to the heel blade length section (Abl) is less than 0.9. The only prior art fairway woods seen in FIG. 34 that fall below this ratio are prior art products O and P, which fall dramatically below the claimed MOI_y or the claim Ycg distance, the specified heel blade length section (Abl), and prior art product O further has a short blade length (BL).

Still a further embodiment uniquely characterizes the present fairway wood golf club head with a ratio of the heel blade length section (Abl) to the blade length (BL) that is at least 0.33. The only prior art product in FIG. 35 that meets this ratio along with a blade length (BL) of at least 3.1 inches is prior art product R, which again has a club moment arm (CMA) more than 17 percent greater than the present invention and thus all the undesirable attributes associated with a long club moment arm (CMA) club.

Yet another embodiment further exhibits a club head attribute that goes against traditional thinking regarding a short club moment arm (CMA) club, such as the present invention. In this embodiment the previously defined transfer distance (TD) is at least 1.2 inches. In this embodiment the present invention is achieving a club moment arm (CMA) less than 1.1 inches while achieving a transfer distance (TD) of at least 1.2 inches. Conventional wisdom would lead one skilled in the art to generally believe that the magnitudes of the club moment arm (CMA) and the transfer distance (TD) should track one another.

In the past golf club design has made MOI_y a priority. Unfortunately, MOI_y is solely an impact influencer; in other words, MOI_y represents the club head's resistance to twisting when a golf ball is struck toward the toe side, or heel side, of the golf club. The present invention recognizes that a second moment of inertia, referred to above as the face closing moment, (MOI_{fc}) also plays a significant role in producing a golf club that is particularly playable by even unskilled golfers. As previously explained, the claimed second moment of inertia is the face closing moment of inertia, referred to as MOI_{fc}, which is the horizontally translated (no change in Y-direction elevation) version of MOI_y around a vertical axis that passes through the origin.

MOI_{fc} is calculated by adding MOI_y to the product of the club head mass and the transfer distance (TD) squared. Thus,

$$\text{MOI}_{fc} = \text{MOI}_y + (\text{mass} \cdot \text{TD})^2$$

The transfer distance (TD) in the equation above must be converted into centimeters in order to obtain the desired MOI units of g*cm². The face closing moment (MOI_{fc}) is important because it represents the resistance felt by a golfer during a swing as the golfer is attempting to return the club face to the square position. While large MOI_y golf clubs are good at resisting twisting when off-center shots are hit, this does little good if the golfer has difficulty consistently bringing the club back to a square position during the swing. In other words, as the golf swing returns the golf club head to its original position to impact the golf ball the face begins closing with the goal of being square at impact with the golf ball. As MOI_y increases, it is often more difficult for golfers to return the club face to the desired position for impact with the ball. For instance, the figures of FIGS. 18(A), (B), (C), and (D) illustrate the face of the golf club head closing during the downswing in preparation for impact with the golf ball. This stepwise closing of the face is also illustrated in FIGS. 19 and 20.

Recently golfers have become accustomed to high MOI_y golf clubs, particularly because of recent trends with modern drivers and hybrid irons. In doing so, golfers have trained themselves, and their swings, that the extra resistance to closing the club face during a swing associated with longer length golf clubs, i.e. high MOI_y drivers and hybrid irons, is the "natural" feel of longer length golf clubs. The graph of FIG. 37 illustrates the face closing moment (MOI_{fc}) compared to club length of modern prior art golf clubs. The left side of solid line curve on the graph illustrates the face closing moment (MOI_{fc}) of an average hybrid long iron golf club, while the right side solid line curve of the graph illustrates the face closing moment (MOI_{fc}) of an average high MOI_y driver. The drop in the illustrated solid line curve at the 43 inch club length illustrates the face closing moment (MOI_{fc}) of conventional fairway woods. Since golfers have trained themselves that a certain resistance to closing the face of a long club length golf club is the "natural" feel, conventional fairway woods no longer have that "natural" feel. The present invention provides a fairway wood with a face closing moment (MOI_{fc}) that is more in line with hybrid long irons and high MOI_y drivers resulting in a more natural feel in terms of the amount of effort expended to return the club face to the square position; all the while maintaining a short club moment arm (CMA). This more natural feel is achieved in the present invention by increasing the face closing moment (MOI_{fc}) so that it approaches the straight dashed line seen in FIG. 37 connecting the face closing moment (MOI_{fc}) of the hybrid long irons and high MOI_y drivers. Thus, one embodiment distinguishes itself by having a face closing moment (MOI_{fc}) of at least 4500 g*cm², or at least 4250 g*cm² in low CG elevation embodiments. Further, this beneficial face closing moment (MOI_{fc}) to club length relationship may be expressed as a ratio. Thus, in yet another embodiment of the present invention the ratio of the face closing moment (MOI_{fc}) to the club length is at least 135, or at least 95 in low CG elevation embodiments.

In the previously discussed embodiment the transfer distance (TD) is at least 1.2 inches. Thus, from the definition of the face closing moment (MOI_{fc}) it is clear that the transfer distance (TD) plays a significant role in a fairway wood's feel during the golf swing such that a golfer squares the club face with the same feel as when they are squaring their driver's club face or their hybrid's club face; yet the benefits

afforded by increasing the transfer distance (TD), while decreasing the club moment arm (CMA), have gone unrecognized until the present invention. The only prior art product seen in FIG. 36 with a transfer distance (TD) of at least 1.2 inches, while also having a club moment arm (CMA) of less than or equal to 1.1 inches, is prior art product I, which has a blade length (BL) over 8 percent less than the present invention, a heel blade length section (Abl) over 21 percent less than the present invention, and a MOIy over 10 percent less than some embodiments of the present invention.

A further embodiment of the previously described embodiment has recognized highly beneficial club head performance regarding launch conditions when the transfer distance (TD) is at least 10 percent greater than the club moment arm (CMA). Even further, a particularly effective range for fairway woods has been found to be when the transfer distance (TD) is 10 percent to 40 percent greater than the club moment arm (CMA). This range ensures a high face closing moment (MOIfc) such that bringing club head square at impact feels natural and takes advantage of the beneficial impact characteristics associated with the short club moment arm (CMA) and CG location.

The embodiments of the present invention discovered that in order to increase the face closing moment (MOIfc) such that it is closer to a roughly linear range between a hybrid long iron and a high MOIy driver, while reducing the club moment arm (CMA), the heel blade length section (Abl) must be increased to place the CG in a more beneficial location. As previously mentioned, the present invention does not merely maximize MOIy because that would be short sighted. Increasing the MOIy while obtaining a desirable balance of club moment arm (CMA), blade length (BL), heel blade length section (Abl), and CG location involved identifying key relationships that contradict many traditional golf club head engineering principles. This is particularly true in an embodiment of the present invention that has a second moment of inertia, the face closing moment, (MOIfc) about a vertical axis through the origin of at least 5000 g*cm². Obtaining such a high face closing moment (MOIfc), while maintaining a short club moment arm (CMA), long blade length (BL), long heel blade length section (Abl), and high MOIy involved recognizing key relationships, and the associated impact on performance, not previously exhibited. In fact, in yet another embodiment one such desirable relationship found to be an indicator of a club heads playability, not only from a typical resistance to twisting at impact perspective, but also from the perspective of the ability to return the club head to the square position during a golf swing with a natural feel, is identified in a fairway wood golf club head that has a second moment of inertia (MOIfc) that is at least 50 percent greater than the MOIy multiplied by seventy-two and one-half percent of the heel blade length section (Abl). This unique relationship is a complex balance of virtually all the relationships previously discussed.

The concept of center face progression (CFP) has been previously defined and is often thought of as the offset of a golf club head, illustrated in FIG. 14. One embodiment of the present invention has a center face progression (CFP) of less than 0.525 inches. Additionally, in this embodiment the Zcg may be less than 0.65 inches, thus leading to a small club moment arm (CMA). In a further embodiment, the present invention has a center face progression (CFP) of less than 0.35 inches and a Zcg is less than 0.85 inches, further providing the natural feel required of a particularly playable fairway wood

Yet another embodiment of the present invention further characterizes this unique high MOIy long blade length (BL) fairway wood golf club having a long heel blade length section (Abl) and a small club moment arm (CMA) in terms of a design efficiency. In this embodiment the ratio of the first moment of inertia (MOIy) to the head mass is at least 14. Further, in this embodiment the ratio of the second moment of inertia, or the face closing moment, (MOIfc) to the head mass is at least 23. Both of these efficiencies are only achievable by discovering the unique relationships that are disclosed herein.

Additional testing has shown that further refinements in the CG location, along with the previously described combination of the small club moment arm (CMA) with the long blade length (BL) and the long heel blade length section (Abl) may exceed the performance of many of the high MOIy embodiments just disclosed. Thus, all of the prior disclosure remains applicable, however now the presently claimed invention does not focus on achieving a high MOIy, in combination with all the other attributes, but rather the following embodiments focus on achieving a specific CG location in combination with the unique relationships of small club moment arm (CMA), long blade length (BL), and long heel blade length section (Abl), already disclosed in detail, in addition to a particular relationship between the top edge height (TEH) and the Ycg distance.

Referring now to FIG. 10, in one embodiment it was found that a particular relationship between the top edge height (TEH) and the Ycg distance further promotes desirable performance and feel. In this embodiment a preferred ratio of the Ycg distance to the top edge height (TEH) is less than 0.40; while still achieving a long blade length of at least 3.1 inches, including a heel blade length section (Abl) that is at least 1.1 inches, a club moment arm (CMA) of less than 1.1 inches, and a transfer distance (TD) of at least 1.2 inches, wherein the transfer distance (TD) is between 10 percent to 40 percent greater than the club moment arm (CMA). This ratio ensures that the CG is below the engineered impact point (EIP), yet still ensures that the relationship between club moment arm (CMA) and transfer distance (TD) are achieved with club head design having a long blade length (BL) and long heel blade length section (Abl). As previously mentioned, as the CG elevation decreases the club moment arm (CMA) increases by definition, thereby again requiring particular attention to maintain the club moment arm (CMA) at less than 1.1 inches while reducing the Ycg distance, maintaining a moderate MOIy, and a significant transfer distance (TD) necessary to accommodate the long blade length (BL) and heel blade length section (Abl). In an even further embodiment, a ratio of the Ycg distance to the top edge height (TEH) of less than 0.375 has produced even more desirable ball flight properties. Generally the top edge height (TEH) of fairway wood golf clubs is between 1.1 inches and 2.1 inches.

In fact, most fairway wood type golf club heads fortunate to have a small Ycg distance are plagued by a short blade length (BL), a small heel blade length section (Abl), and/or long club moment arm (CMA). With reference to FIG. 3, one particular embodiment achieves improved performance with the Ycg distance less than 0.65 inches, while still achieving a long blade length of at least 3.1 inches, including a heel blade length section (Abl) that is at least 1.1 inches, a club moment arm (CMA) of less than 1.1 inches, and a transfer distance (TD) of at least 1.2 inches, wherein the transfer distance (TD) is between 10 percent to 40 percent greater than the club moment arm (CMA). As with the prior disclosure, these relationships are a delicate balance among

many variables, often going against traditional club head design principles, to obtain desirable performance. Still further, another embodiment has maintained this delicate balance of relationships while even further reducing the Ycg distance to less than 0.60 inches.

As previously touched upon, in the past the pursuit of high MOI_y fairway woods led to oversized fairway woods attempting to move the CG as far away from the face of the club, and as low, as possible. With reference again to FIG. 8, this particularly common strategy leads to a large club moment arm (CMA), a variable that the present embodiment seeks to reduce. Further, one skilled in the art will appreciate that simply lowering the CG in FIG. 8 while keeping the Zcg distance, seen in FIGS. 2 and 6, constant actually increases the length of the club moment arm (CMA). The present invention is maintaining the club moment arm (CMA) at less than 1.1 inches to achieve the previously described performance advantages, while reducing the Ycg distance in relation to the top edge height (TEH); which effectively means that the Zcg distance is decreasing and the CG position moves toward the face, contrary to many conventional design goals.

As explained throughout, the relationships among many variables play a significant role in obtaining the desired performance and feel of a fairway wood. One of these important relationships is that of the club moment arm (CMA) and the transfer distance (TD). The present fairway wood has a club moment arm (CMA) of less than 1.1 inches and a transfer distance (TD) of at least 1.2 inches; however in one particular embodiment this relationship is even further refined resulting in a fairway wood golf club having a ratio of the club moment arm (CMA) to the transfer distance (TD) that is less than 0.75, resulting in particularly desirable performance. Even further performance improvements have been found in an embodiment having the club moment arm (CMA) at less than 1.0 inch, and even more preferably, less than 0.95 inches. A somewhat related embodiment incorporates a mass distribution that yields a ratio of the Xcg distance to the Ycg distance of at least two, thereby ensuring the performance and feel of a fairway wood golf club head having a second moment of inertia (MOI_{fc}) of at least 4250 g*cm². In fact, in these embodiments it has been found that a first moment of inertia (MOI_y) about a vertical axis through the CG of at least 2000 g*cm², when combined with the claimed transfer distance (TD), yield acceptable second moment of inertia (MOI_{fc}) values that provide a comfortable feel to most golfers. One particular embodiment further accommodates the resistance that modern golfers are familiar with when attempting to bring the club face square during a golf swing by incorporating a ratio of a second moment of inertia (MOI_{fc}) to the club length that is at least 95.

Achieving a Ycg distance of less than 0.65 inches requires a very light weight club head shell so that as much discretionary mass as possible may be added in the sole region without exceeding normally acceptable head weights for fairway woods, as well as maintaining the necessary durability. In one particular embodiment this is accomplished by constructing the shell out of a material having a density of less than 5 g/cm³, such as titanium alloy, nonmetallic composite, or thermoplastic material, thereby permitting over one-third of the final club head weight to be discretionary mass located in the sole of the club head. One such nonmetallic composite may include composite material such as continuous fiber pre-preg material (including thermosetting materials or thermoplastic materials for the resin). In yet another embodiment the discretionary mass is composed of

as tungsten. An even further embodiment obtains a Ycg distance is less than 0.55 inches by utilizing a titanium alloy shell and at least 80 grams of tungsten discretionary mass, all the while still achieving a ratio of the Ycg distance to the top edge height (TEH) is less than 0.40, a blade length (BL) of at least 3.1 inches with a heel blade length section (Abl) that is at least 1.1 inches, a club moment arm (CMA) of less than 1.1 inches, and a transfer distance (TD) of at least 1.2 inches.

A further embodiment recognizes another unusual relationship among club head variables that produces a fairway wood type golf club exhibiting exceptional performance and feel. In this embodiment it has been discovered that a heel blade length section (Abl) that is at least twice the Ycg distance is desirable from performance, feel, and aesthetics perspectives. Even further, a preferably range has been identified by appreciating that performance, feel, and aesthetics get less desirable as the heel blade length section (Abl) exceeds 2.75 times the Ycg distance. Thus, in this one embodiment the heel blade length section (Abl) should be 2 to 2.75 times the Ycg distance.

Similarly, a desirable overall blade length (BL) has been linked to the Ycg distance. In yet another embodiment preferred performance and feel is obtained when the blade length (BL) is at least 6 times the Ycg distance. Such relationships have not been explored with conventional fairway wood golf clubs because exceedingly long blade lengths (BL) would have resulted. Even further, a preferable range has been identified by appreciating that performance and feel become less desirable as the blade length (BL) exceeds 7 times the Ycg distance. Thus, in this one embodiment the blade length (BL) should be 6 to 7 times the Ycg distance.

Just as new relationships among blade length (BL) and Ycg distance, as well as the heel blade length section (Abl) and Ycg distance, have been identified; another embodiment has identified relationships between the transfer distance (TD) and the Ycg distance that produce a particularly playable fairway wood. One embodiment has achieved preferred performance and feel when the transfer distance (TD) is at least 2.25 times the Ycg distance. Even further, a preferable range has been identified by appreciating that performance and feel deteriorate when the transfer distance (TD) exceeds 2.75 times the Ycg distance. Thus, in yet another embodiment the transfer distance (TD) should be within the relatively narrow range of 2.25 to 2.75 times the Ycg distance for preferred performance and feel.

All the ratios used in defining embodiments of the present invention involve the discovery of unique relationships among key club head engineering variables that are inconsistent with merely striving to obtain a high MOI_y or low CG using conventional golf club head design wisdom. Numerous alterations, modifications, and variations of the preferred embodiments disclosed herein will be apparent to those skilled in the art and they are all anticipated and contemplated to be within the spirit and scope of the instant invention. Further, although specific embodiments have been described in detail, those with skill in the art will understand that the preceding embodiments and variations can be modified to incorporate various types of substitute and or additional or alternative materials, relative arrangement of elements, and dimensional configurations. Accordingly, even though only few variations of the present invention are described herein, it is to be understood that the practice of such additional modifications and variations and the equivalents thereof, are within the spirit and scope of the invention as defined in the following claims.

We claim:

1. A golf club comprising:
 - a shaft having a proximal end and a distal end;
 - a grip attached to the shaft proximal end; and
 - a golf club head attached to the shaft distal end producing a club length of at least 41 inches and no more than 45 inches, wherein the golf club head includes:
 - (a) a face positioned at a front portion of the golf club head where the golf club head impacts a golf ball, the face has a loft of at least 12 degrees and no more than 27 degrees, and the face includes an engineered impact point and a top edge height of 1.1-2.1 inches;
 - (b) a sole positioned at a bottom portion of the golf club head;
 - (c) a crown positioned at a top portion of the golf club head;
 - (d) a skirt positioned around a portion of a periphery of the golf club head between the sole and the crown, wherein the face, sole, crown, and skirt define an outer shell that further defines a head volume that is less than 250 cubic centimeters, a portion of the shell has a density of less than 5 g/cc, and the golf club head has a rear portion opposite the face;
 - (e) a bore having a center that defines a shaft axis which intersects with a horizontal ground plane to define an origin point, wherein the bore is located at a heel side of the golf club head and receives the shaft distal end for attachment to the golf club head, and wherein a toe side of the golf club head is located opposite of the heel side;
 - (f) a blade length measured horizontally from the origin point toward the toe side of the golf club head a distance that is generally parallel to the face and the ground plane to the most distant point on the golf club head in this direction, wherein the blade length includes a heel blade length section measured in the same direction as the blade length from the origin point to the engineered impact point;
 - (g) a club head mass of less than 230 grams;
 - (h) a center of gravity (CG) located:
 - (1) vertically toward the top portion of the golf club head from the origin point a distance Y_{cg} ;
 - (2) horizontally from the origin point toward the toe side of the golf club head a distance X_{cg} that is generally parallel to the face and the ground plane;
 - (3) a distance Z_{cg} from the origin toward the rear portion in a direction generally orthogonal to the vertical direction used to measure Y_{cg} and generally orthogonal to the horizontal direction used to measure X_{cg} , wherein the Z_{cg} distance is less than 0.65 inches;
 - (4) such that a club moment arm is a distance from the CG to the engineered impact point, wherein the club moment arm is less than 1.1 inches, a transfer distance is a horizontal distance from the CG to a vertical line extending from the origin point, and a CG angle from the origin point to the center of gravity is no more than 30 degrees; and
 - (i) a first moment of inertia (MOI_y) about a vertical axis through the CG of at least 2000 g*cm².
2. The golf club of claim 1, wherein the club moment arm is less than 1.0 inches and a portion of the shell is made of non-metallic composite material.
3. The golf club of claim 2, wherein the club moment arm is less than 0.95 inches and the CG angle is no more than 25 degrees.

4. The golf club of claim 3, wherein the transfer distance is no more than 40 percent greater than the club moment arm and a second moment of inertia (MOI_{fc}) about a vertical axis through the origin is at least 4250 g*cm².
5. The golf club of claim 3, wherein the face has a center face progression of less than 0.525 inches and the transfer distance is no more than 40 percent greater than the club moment arm.
6. The golf club of claim 3, wherein a second moment of inertia (MOI_{fc}) is about a vertical axis through the origin, and a ratio of the second moment of inertia (MOI_{fc}) to the club length is at least 95.
7. The golf club of claim 6, wherein the head volume is less than 170 cubic centimeters.
8. The golf club of claim 6, wherein the transfer distance that is least 10 percent greater than the club moment arm.
9. The golf club of claim 6, wherein a portion of the golf club head has a density of at least 15 g/cc.
10. The golf club of claim 2, wherein a ratio of the heel blade length section to a front-to-back dimension is at least 0.32.
11. The golf club of claim 3, wherein the Y_{cg} distance is less than 0.65".
12. A golf club comprising:
 - a shaft having a proximal end and a distal end;
 - a grip attached to the shaft proximal end; and
 - a golf club head attached to the shaft distal end producing a club length of at least 41 inches and no more than 45 inches, the golf club head having:
 - (a) a face positioned at a front portion of the golf club head where the golf club head impacts a golf ball, wherein the face has a loft of at least 12 degrees and no more than 27 degrees, and wherein the face includes an engineered impact point and a top edge height of 1.1-2.1 inches, and the face has a center face progression;
 - (b) a sole positioned at a bottom portion of the golf club head;
 - (c) a crown positioned at a top portion of the golf club head;
 - (d) wherein an outer shell defines a head volume, and the golf club head has a rear portion opposite the face and a front-to-back dimension from a furthest forward point on the face to the furthest rearward point at the rear portion of the golf club head;
 - (e) a bore having a center that defines a shaft axis which intersects with a horizontal ground plane to define an origin point, wherein the bore is located at a heel side of the golf club head and receives the shaft distal end for attachment to the golf club head, and wherein a toe side of the golf club head is located opposite of the heel side;
 - (f) a blade length measured horizontally from the origin point toward the toe side of the golf club head a distance that is generally parallel to the face and the ground plane to the most distant point on the golf club head in this direction, wherein the blade length includes a heel blade length section measured in the same direction as the blade length from the origin point to the engineered impact point;
 - (g) a club head mass of less than 230 grams;
 - (h) a center of gravity located:
 - (1) vertically toward the top portion of the golf club head from the origin point a distance Y_{cg} , wherein the Y_{cg} distance is less than 0.65";

19

- (2) horizontally from the origin point toward the toe side of the golf club head a distance X_{cg} that is generally parallel to the face and the ground plane; and
 - (3) a distance Z_{cg} from the origin toward the rear portion in a direction generally orthogonal to the vertical direction used to measure Y_{cg} and generally orthogonal to the horizontal direction used to measure X_{cg} ;
 - (4) such that a club moment arm is a distance from the CG to the engineered impact point, a transfer distance is a horizontal distance from the CG to a vertical line extending from the origin point; and
 - (i) a first moment of inertia (MOI_y) about a vertical axis through the CG of at least $2000 \text{ g}\cdot\text{cm}^2$, a second moment of inertia (MOI_{fc}) about a vertical axis through the origin of at least $4250 \text{ g}\cdot\text{cm}^2$, a ratio of the first moment of inertia (MOI_y) to the club head mass is at least 14, and a ratio of the second moment of inertia (MOI_{fc}) to the club length is at least 95.
13. The golf club of claim 12, wherein the first moment of inertia (MOI_y) is at least $3000 \text{ g}\cdot\text{cm}^2$ and the second moment of inertia (MOI_{fc}) is at least $4500 \text{ g}\cdot\text{cm}^2$.
14. The golf club of claim 13, wherein the face has a center face progression of less than 0.525 inches.
15. The golf club of claim 14, wherein a ratio of the second moment of inertia (MOI_{fc}) to the club head mass is at least 23.
16. The golf club of claim 15, wherein the Y_{cg} distance is less than 0.60".
17. The golf club of claim 15, wherein the head volume is 170-250 cubic centimeters.
18. The golf club of claim 15, wherein the Z_{cg} distance is less than 0.65" and the club moment arm is less than 1.1 inches.
19. The golf club of claim 14, wherein a CG angle from the origin point to the center of gravity is no more than 30 degrees.
20. A golf club comprising:
- a shaft having a proximal end and a distal end;
 - a grip attached to the shaft proximal end; and
 - a golf club head attached to the shaft distal end producing a club length of at least 41 inches and no more than 45 inches, wherein the golf club head includes:
- (a) a face positioned at a front portion of the golf club head where the golf club head impacts a golf ball, the face has a loft of at least 12 degrees and no more than 27 degrees, and the face includes an engineered impact point and a top edge height of 1.1-2.1 inches;

20

- (b) a sole positioned at a bottom portion of the golf club head;
- (c) a crown positioned at a top portion of the golf club head;
- (d) a skirt positioned around a portion of a periphery of the golf club head between the sole and the crown, wherein the face, sole, crown, and skirt define an outer shell that further defines a head volume that is less than 250 cubic centimeters, and the golf club head has a rear portion opposite the face;
- (e) a bore having a center that defines a shaft axis which intersects with a horizontal ground plane to define an origin point, wherein the bore is located at a heel side of the golf club head and receives the shaft distal end for attachment to the golf club head, and wherein a toe side of the golf club head is located opposite of the heel side;
- (f) a blade length measured horizontally from the origin point toward the toe side of the golf club head a distance that is generally parallel to the face and the ground plane to the most distant point on the golf club head in this direction, wherein the blade length includes a heel blade length section measured in the same direction as the blade length from the origin point to the engineered impact point;
- (g) a club head mass of less than 230 grams;
- (h) a center of gravity (CG) located:
 - (1) vertically toward the top portion of the golf club head from the origin point a distance Y_{cg} ;
 - (2) horizontally from the origin point toward the toe side of the golf club head a distance X_{cg} that is generally parallel to the face and the ground plane;
 - (3) a distance Z_{cg} from the origin toward the rear portion in a direction generally orthogonal to the vertical direction used to measure Y_{cg} and generally orthogonal to the horizontal direction used to measure X_{cg} , wherein the Z_{cg} distance is less than 0.65 inches;
 - (4) such that a club moment arm is a distance from the CG to the engineered impact point, wherein the club moment arm is less than 1.0 inches, a transfer distance is a horizontal distance from the CG to a vertical line extending from the origin point, and a CG angle from the origin point to the center of gravity is no more than 25 degrees; and
- (i) a first moment of inertia (MOI_y) about a vertical axis through the CG of at least $2000 \text{ g}\cdot\text{cm}^2$.

* * * * *